

# HO3USSBA

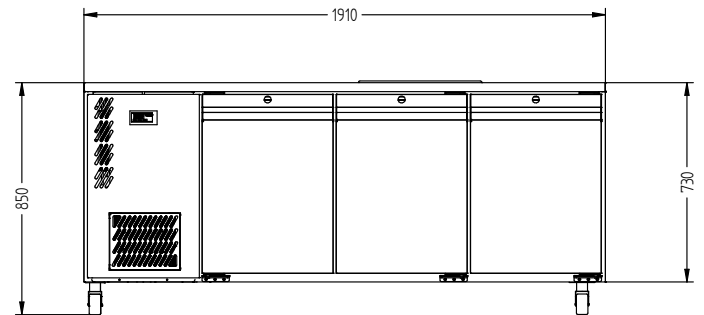

CATEGORY	FOODSERVICE COUNTERS
RANGE	<b>Opal</b>
UNIT	REFRIGERATOR
TYPE	SELF CONTAINED
DOORS	3

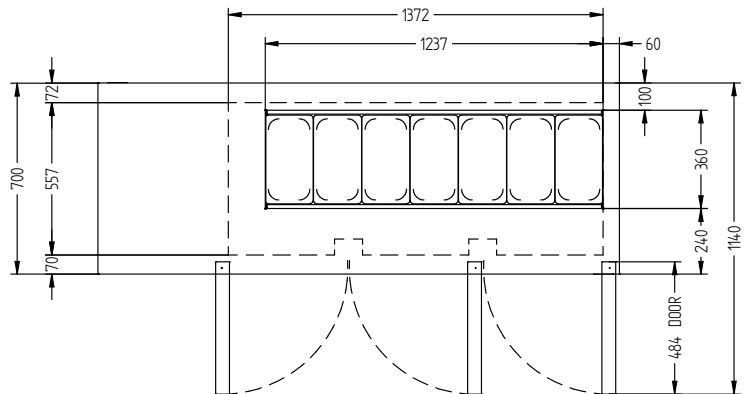
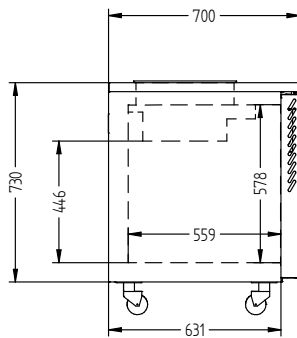
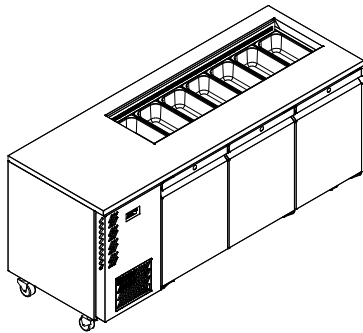

## SPECIFICATIONS

CAPACITY LITRES	510
TEMPERATURE	1°C / 4°C
FRONT BREATHING	YES
DIMENSIONS - W X D X H (ON 120 MM H CASTORS) MM	1910 W x 700 D x 850 H
WEIGHT UNPACKED (KG)	160

## STANDARD INCLUSIONS \*\*\*

DOOR TYPE	Standard: SD (Solid Door)    Optional: DR (Drawer)
FINISH (INTERIOR AND EXTERIOR EXCLUDING REAR AND UNDER)	SS (Stainless Steel)
SHELVES/DOOR	1
BLOWN AIRWELL (100MM DEEP 1/3 PANS INCLUDED)	7 X 1/3 PANS

## ELECTRICAL

POWER SUPPLY	10 amp
POWER CABLE LENGTH (METRES)	2
RUNNING AMPS	4.6

## GAS TYPE

REFRIGERANT	R134a
-------------	-------

\*\*\* For **OPTIONS** refer to the current Williams Price Guide