

HUSSMANN®

austral
REFRIGERATION



MJPE Multideck and SMD/SME Low Height Multideck Case Installation Manual

Reference: IM-1004

66 Glendenning Road, Glendenning NSW 2761
PO Box 42 Doonside NSW 2767
t: +61 2 8805 0400 f: +61 2 9675 2897

Contents

Pre installation	<hr/>	2
Case services dimensions		2
Operating environment		4
Handling and transporting cases		4
Shipping damages and shortages		4
Installation	<hr/>	5
Positioning and levelling		5
Sealing case joins		7
Joining the cases		8
Attaching kickplates		11
Connecting refrigerant lines		13
Installing the waste drain		15
Installing sensor probes		16
Mounting fixtures		17
Commissioning	<hr/>	18
Cleaning case		18
Starting up		18
Start up checks		18
Decommissioning	<hr/>	19
Disposal	<hr/>	19
Troubleshooting	<hr/>	20
Appendixes	<hr/>	21
Appendix 1	Wiring diagrams	21
Appendix 2	Risk analysis	22
Appendix 3	Warranty	23

Pre installation

Case Services Dimensions

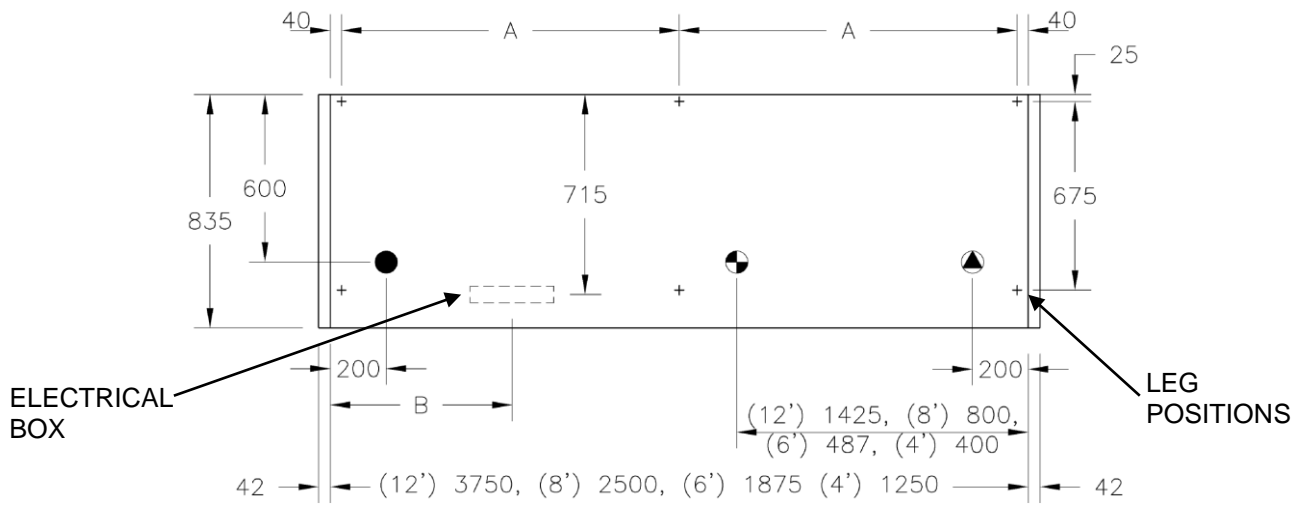

LEG and ELECTRICAL BOX POSITION

LENGTH	A	B
1250	-	870
1875	-	655
2500	-	985
3750	1835	930

- DRAIN
- ELECTRICAL
- REFRIGERATION

SMD/SME

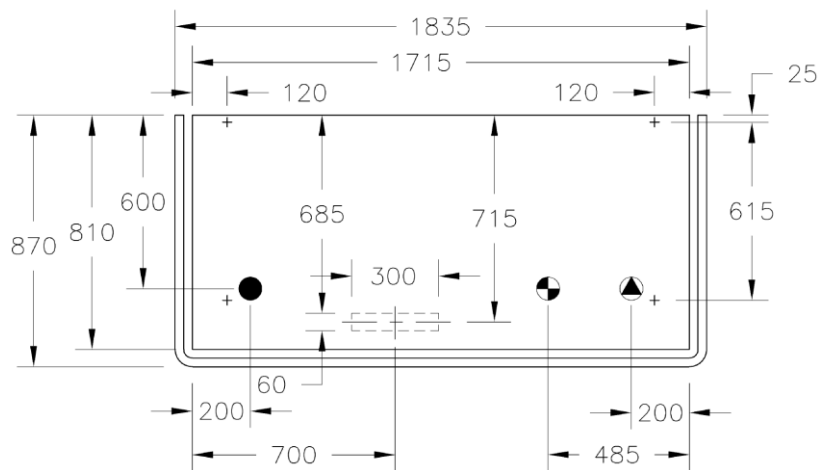

SMD/SME - CROWN

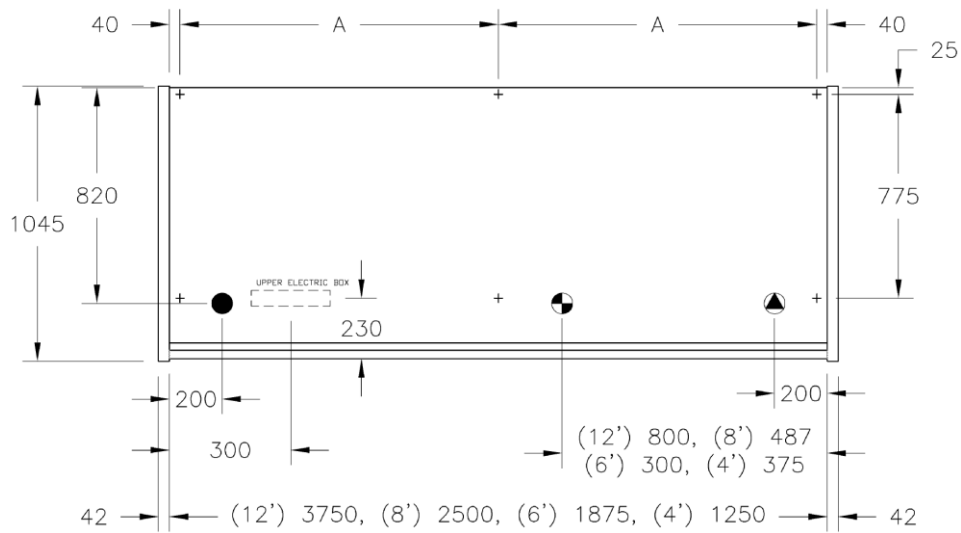

MJPE

LEG POSITIONS

LENGTH	A
1250	-
1875	-
2500	-
3750	1835

- DRAIN
- ELECTRICAL
- REFRIGERATION

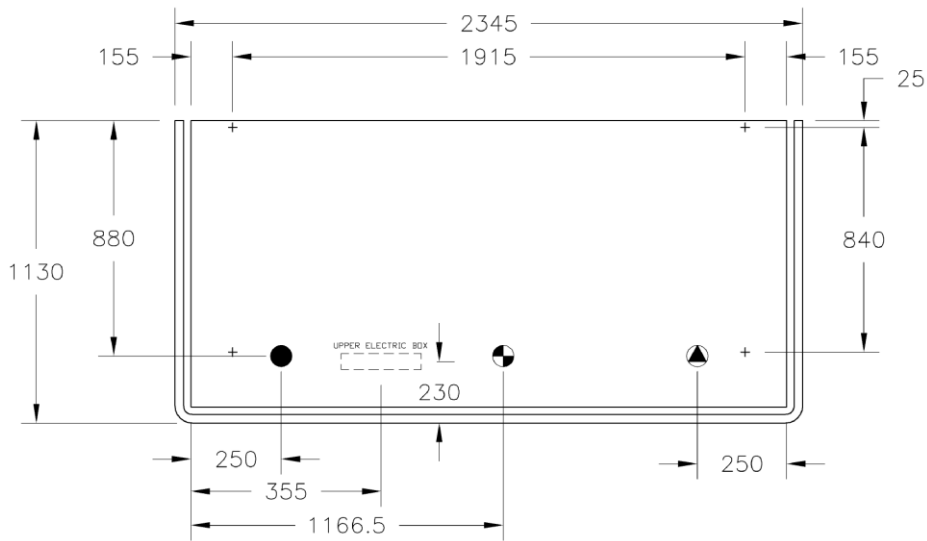

MJPE - CROWN

Figure 1:- Service layout for cases

NOTE: This information is a reference only. Always refer to the latest Product Engineering Data sheet.

Operating Environment

Cases have been factory tested to AS1731, 25°C at 60% RH. For best performance, store temperature should be maintained at or below 24°C at 50% RH, if not an “air ventilation kit” may be required.

To avoid condensation build-up, cases should be positioned to allow air to freely circulate around the underside and rear of the case. Ideally, the floor will be level.

Cases must not be positioned in areas that may be subject to heat or air currents such as ventilation ducts, open doors or windows, direct sunlight, electric fans or ovens, etc.



NOTE

Refer to product MSDS for all hazardous substances used during installation in relation to their application, PPE, first aid, disposal and emergency management.
Refer page 20 (Risk Analysis)

For MSDS sheet contact your Hussmann Representative

Handling and Transporting cases

Case dimensions can be found in the product engineering data sheets.

(This manual is a guide only. Always refer to the latest case information available from Hussmann Customer Service)

Always ensure that the moving device is of a suitable type, and has sufficient lifting capacity for the case weight and dimension. Always lift cases from the underside.

Refer to and follow the manual handling policies of your Company when moving cases.



CAUTION

Care must be taken to avoid damage to drainage outlets and electrical equipment mounted under or at the rear of cases.

Shipping Damage and Shortages

If possible, it is recommended that packaging be removed from the cases before they are moved into the store.

After removing packaging, inspect the case for any shipping damage and ensure that all case inclusions, such as trims etc are accounted for. Immediately report any shipping damage to the carrier and inform Hussmann Customer Service of any short supplies.

Installation



NOTE

Information in this manual is to be followed in conjunction with specifications, work practices and regulations of the customer, installing company and relevant industry.

Unwrap the cabinet and remove the shipping braces. Lift up cabinet and remove shipping base



Figure 2 Levelling feet adjustment

Positioning and Levelling



CAUTION

Ensure the lifting capacity of the trolley, etc is sufficient for the case. Refer to the product engineering data tables at the front of this manual for case weights and Risk Analysis (page 22).

To position the cases:

1. If the plinth surface is not level, determine where the highest point of the plinth is, and position the case allocated to this position first.
2. Snap a chalk line on the floor to use as a guide for positioning the front of the cases in the line-up. Determine the position of the case and choose a part of the case that will relate to the chalk line.
3. Adjust the case height using the adjustable feet (if fitted) or metal shims (do **NOT** use **timber**) to ensure the case is level to **within +/- 1.5mm** from front to back and side to side and chassis of case is **NOT twisted**. Maximum 30mm adjustment.

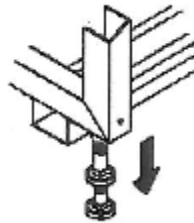

Figure 3:- Levelling feet adjustment



NOTE

It is important that all cases are level for correct case joining and operation.

DO **NOT** SET CASE LEVELS OFF THE PATCH END fitted to a case.



Make sure case is level:
Front to Back: +/- 1.5mm
Side to Side: +/- 1.5mm

Make sure Chassis
of case is **NOT**
TWISTED.



Figure 4:- Case levelling



Figure 5:- Line up cases

Sealing Case Joins

Before joining, all cases must be sealed to protect against water and air leakage.

To seal the joins

1. Remove the shelving, racks, mirrors etc, from the end bays, where necessary



CAUTION
Take care if removing Shelves when joining the cases
Shelf light leads may need to be disconnected

2. Cases joints must be air tight to prevent formation of ice or condensation. Foam tape has already been fitted to the end of the case. Check to ensure sealing integrity can be achieved, remedy if foam tape has been damaged, before final joining of both cases together.

Foam tape. (already fitted)



Figure 6:- Prepare cases for joining

Joining the Cases

Ensure cases are sealed before joining them to other cases



CAUTION
Do not walk or sit on cases.

To join the cases

1. Align the canopy by inserting the “multiplexing rods” into the aluminium canopy decoration panel

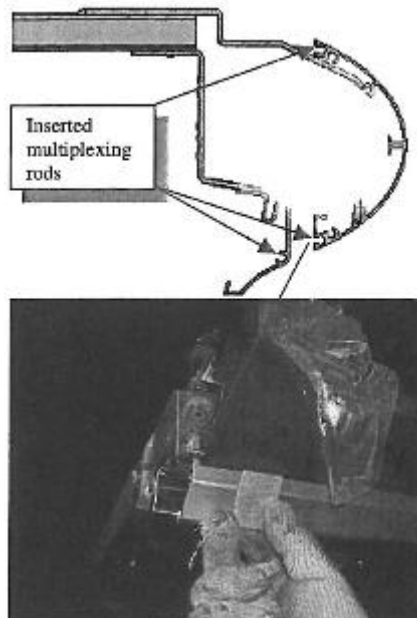

Figure 7:- Insert multiplexing rods for joining

2. Draw up the required case tightly against the case already in position



CAUTION
Case joining bolts should only be used, with care, at the final pulling-up stage.

3. Use hex bolt M8, hex nut M8, plane washer M8 and spring washer M8 to connect with joining frame of each case through the access holes.
4. Ensure that the case is level, from front to back and side to side, with the existing case.
5. Insert the joining bolts, found in the blister pack, into the end holes and tighten

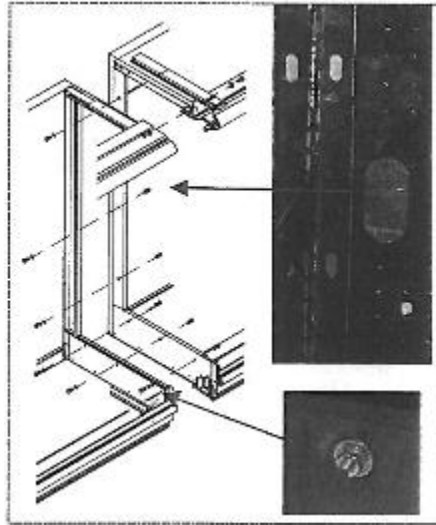

Figure 8:- Joining cases



Seal along this edge only when cases are joined together

Figure 9:- Seal between cases

6. Apply either black or white silicon (depending on the interior colour of the case) all the way along the top of the join, between the endframes of the cases, only
7. Applying slight pressure, run your finger along the length of the silicon.

Joining and Lining up an End Case

The additional steps necessary when lining up an End case, involves:

- There are additional locating holes with rivnuts in the back of the Crown case.
- Screw the threaded rod into these holes.
- Keep screwing the rod into place until 15mm still protrudes, proud of the surface of the back of the case.

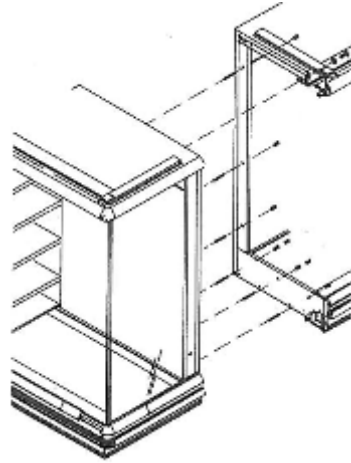

Figure 10:- Joining the end case

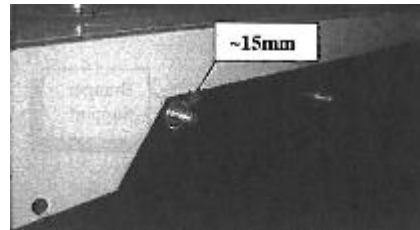

Figure 11:- End case fixing bolts

- Pull up the next case and the End case.
- Carefully push the next case to ensure the threaded rods can be located to the connection holes of the next cases.
- Use the M8 plain washer and nuts to tighten them together.



Figure 12:- End case join

Attaching Kickplates

(This should be done after final Installation of Refrigeration and Drainage connections)

- Use hex screws 6.3 x 19mm to fix the kickplate support to the base. (These parts are in the accessories box).
- Do NOT fix the kickplate support to the base too tightly. It should be able to slip up and down through the oblong hole. This will enable the kickplate to be moveable and it will naturally sit correctly in relation to the floor.



Figure 13:- Kickplate support assembly

- Cut the gasket 45° and fit to the lower kickplate panel.

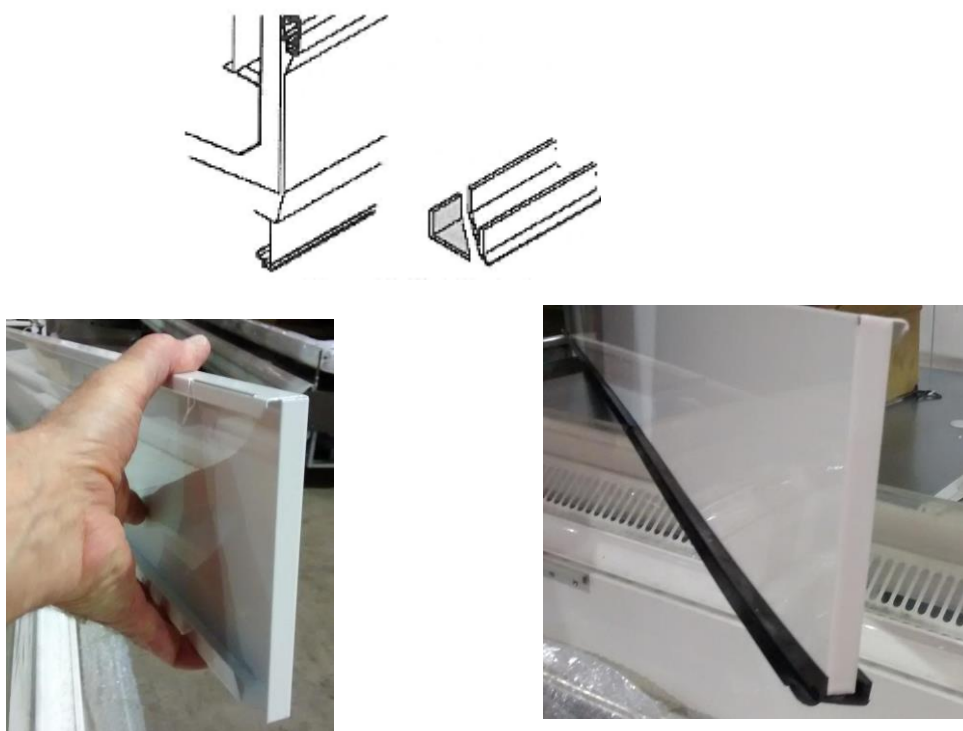

Figure 14:- Kickplate assembly

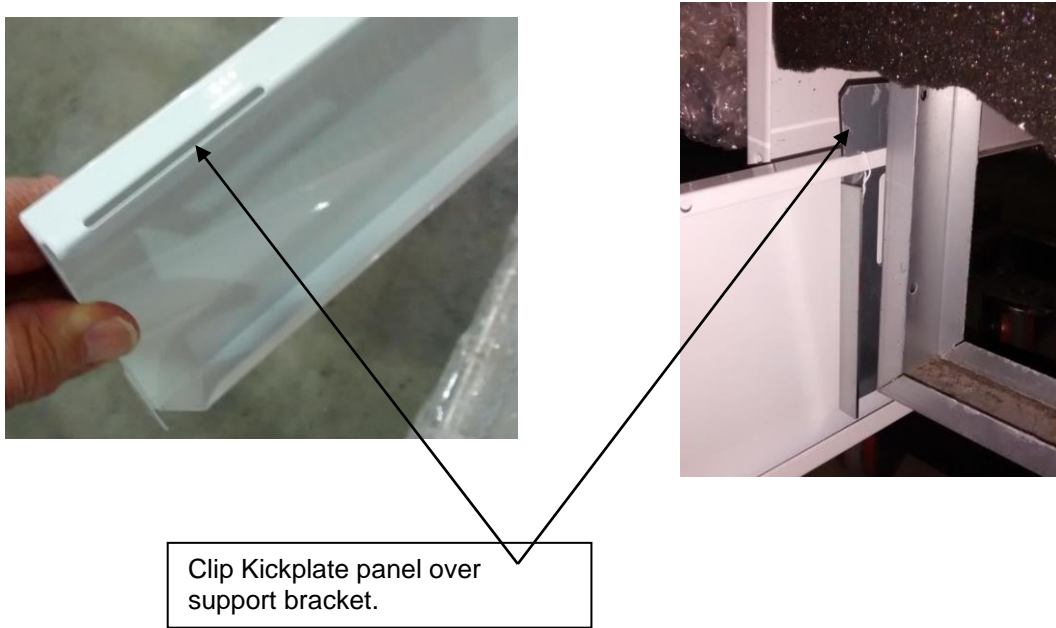

Figure 15:- Install lower kickplate

Connecting Refrigerant Lines

Connection of refrigeration lines is to be undertaken by **qualified persons only**.

Refrigeration pipes are located under the pan decks and can be run from case to case through designated access holes in the end frames and/or out via the base of the case. See figure 1: service layout for location of the refrigerant up-stand.

Up to four cases can share one refrigeration up-stand, however, to ensure best performance, it is recommended that no more than three cases share an up-stand.

The evaporator coils have been charged with dry nitrogen in the factory.



Figure 16:- Refrigeration connection

CAUTION

Do not run refrigeration lines from another compressor through a case.



Since pressure in the first system responds to the coldest location, refrigeration lines from the first system running through a second system may be chilled to the point that its pressure control will respond to the pressure from the second system. This is called cross controlling and should be avoided.

To connect refrigeration lines:

1. Ensure the evaporator coils are fully charged by checking the dry nitrogen holding charge against the pressure written on the tag attached to the coil – it should read between 450kpa and 500kpa.
2. Braze the pipes to the coil using dry nitrogen to prevent any foreign matter being left in the lines. Keep pressure below 1700kPa (250 Psig).

CAUTION

Remove or protect the expansion (TX) valve feeler bulbs (or power lead if electronic valve) from heat.



Ensure the power lead is clear of heat and flame.

3. Insulate all external pipe work to Standard practice and Customer specifications.
4. Seal off all external access holes with polyurethane foam and then bituminous paint to prevent leakage and condensation.
5. Connect to condensing unit or compressor.
6. Pressure test all welded and fastened connections to ensure they are free of leaks.
7. Dehydrate the refrigeration system using the triple evacuation method. Use a vacuum pump to 1000 microns for the first two evacuations and 500 microns on the third, or to the customer's specific requirements. Break evacuations 1 and 2 with dry nitrogen, allowing the pressure to rise above atmospheric pressure each time.
8. Charge with refrigerant after final (3rd) evacuation.

Installing a Waste Drain



NOTES

Drains must be connected to local council requirements.

All joins must be solvent welded.

Each case must be connected to its own waste drain See figure 1: service layout for of the drain up-stand. The case is supplied with the Ø40mm (outside diameter) PVC piping, drain trap and elbows

To install a waste drain:

1. Install PVC drain parts using recommended PVC cleaner, primer and cement per manufacturer's recommendation.



CAUTION

Incorrectly installed drain traps will result in adverse air leaking into the case.

2. Apply PVC specific threaded pipe sealer on the male threads of the plug.
3. Thread plug into adapter until snug, but not to exceed four (4) full rotations.
4. Installed drain piping may require additional support depending on the number and location of the hub floor drains. The installer should always provide adequate support to all drain piping arrangements to prevent excess stress on all drain piping components. The installer must provide additional support when "evac" type waste water systems are applied.

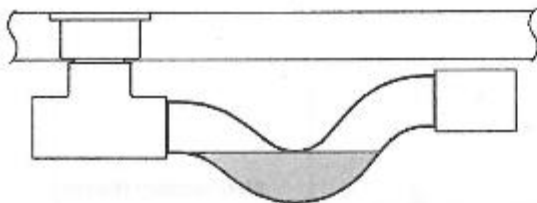

**Water Seal
Correct**

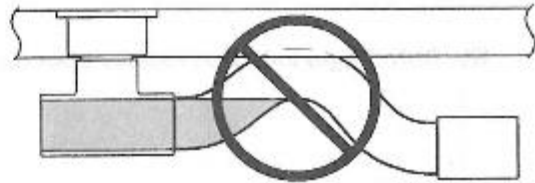

**Water Seal
NOT Correct**



figure 17 drain trap orientation

5. Test for leakage by pouring water down the drain and ensure trap is primed before starting refrigeration.
6. NOTE: All joints to be glued with suitable adhesive.

Installing Sensor Probes

If required and not already fitted, one sensor probe needs to be installed (supplied by installation contractor) in the ceiling panel of each case.



CAUTION

Refer to relevant State or Territory legislation relating to safe working heights.

To install the probe:

1. Unscrew the plate from the ceiling panel to get access to the conduit for the probe wire. A coloured piece of wire acting as a draw string is located behind the plate in the conduit (see figure 18: location of probe)

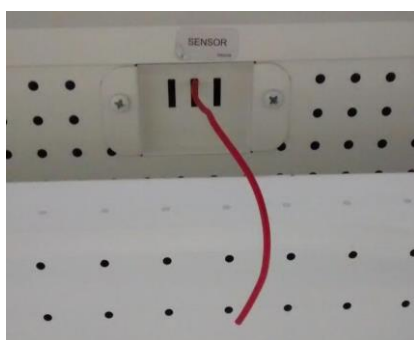

Inside case in ceiling

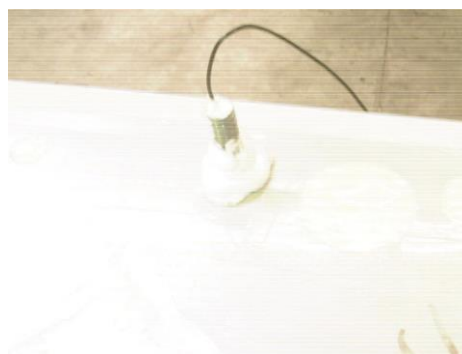

Outside roof of case

figure 18 location of probe

2. Attach the sensor to the back of the plate inside the case.
3. Secure the end of the sensor wire to the draw string wire.
4. On the roof of the case, pull draw wire and sensor wire all the way through the conduit.
5. Seal end of the conduit with putty or silicon
6. Repeat for each case.



CAUTION

Do not walk or sit on cases.

Mounting fixtures

Replace racks and shelves etc, as necessary to store requirements



NOTE

Incorrect shelf configurations may compromise case performance.

Commissioning

Cleaning case

- Remove the PVC protective coating on stainless steel, where applicable
- Remove any residue, silicon or tape marks with a cloth moistened with rubbing alcohol
- Remove all debris from in and around the case
- Wipe case with a clean, damp cloth, if necessary

Starting up

- Check supply power is ready and correct voltage. (by Licensed Person)
- Confirm correct operation of RCD (if fitted) (by Licensed Person)

Turn case power on

Start up checks – by qualified persons only

- Ensure that the drain trap is installed the right way up (refer to figure 7: drain trap orientation in the section installing the waste drain)
- Check that all fans and lights (and light RCDs, if installed) are working correctly.
- Check the anti sweat circuit, ensuring the thermostat is set correctly.
- Set expansion valves and EPRs as per Product Engineering Data – Available from Hussmann.
- Approximately 24 hours after start-up, check that the case is at correct operating temperature (refer the Product Engineering Data).

Decommissioning

Plan and risk assess the decommissioning process to include the following:

- Isolate the case from both the refrigeration and electrical systems. Disconnection is to be undertaken by qualified persons only.
- Removal of the case is to be in the reverse order of installation listed previously.

Disposal

Case disposal is to be carried out by the following:

- Metal component removed and recycled
- Remaining by commercial waste management

Trouble shooting

issue	possible reason	remedial action
Product temperature is higher than requirement	Store condition is warmer or more humid than climate class 3 (25°C/60%RH)	Check store air conditioner operation
	Refrigeration plant is not running or operating at inappropriate settings or conditions	Check for compressor rack if it is running. If rack is running and other possible reasons are eliminated then call refrigeration mechanic to check plant operation.
	Evaporator pressure is not set correctly	Check suction pressure settings at the case and if required adjust as per case specification
	Insufficient or no air flow appears at the case air curtain	Check if case fans are turned on or operating correctly. If any doubt of fan operation contact technician.
		Check if coil is frozen up. If frozen then check defrost settings as per the manufacturers guideline or set to suite the store operating condition. A colder store may require longer defrost duration. A humid store may need more frequent defrost.
	Case shelf arrangement has been deviated significantly from original specified setup	Re-do the shelf arrangement as per the original specification
	Air Return is blocked by merchandise	Remove merchandise to behind the load limit.
None of above	Contact Hussmann	
Products are freezing up	Store condition is too cold compared to design climate class 3	Check store air conditioner operation. If store condition can not be lifted, then adjust cabinet evaporator pressure and defrost strategy to suite
	Case evaporator pressure is lower than specification.	Adjust cabinet evaporator pressure to suite
Cabinet exterior is sweating	Store humidity is high	Check store air conditioner operation
	Insufficient ventilation	Check case ventilation under and at rear of the case. A fan kit may be needed. KITS: (Option Extra – ref Page 21) Case to Wall: 2500: 96A15-035 3750: 96A15-036
	Icon Controller settings (if fitted)	Check settings
	Case SST	SST set too low
Lights are not working	No power supply	Check supply is “on” and light switch is working.
	Lamp fittings (Tombstone, starter and ballast) are faulty	Call technician to check and replace in necessary
	Lamp failed	Replace lamp

Table 1:- Troubleshooting

Appendixes

Appendix 1 **Wiring diagrams** – Supplied with each case.

Appendix 2 Risk analysis

Hazard	Control Measures
Electrical - Replacement of electrical components	Request a service call. Electrically isolate cases before works
Ergonomic - Moving/ positioning/ adjusting cases	Staff must be trained in the correct procedures for setting up cases and ergonomic practices. PPE must be worn
Falling - Connecting sensor probe wiring during installation	Use of barriers & fall arrest systems as appropriate & in accordance with State & Territory Legislation. Safe working at heights
Entanglement - Contact with fans when cleaning	Electrically isolate cases before work is carried out. Staff training,
Cuts and stabbing - Potential for cuts from broken fluorescent tube or during tube replacement	Electrically isolate cases. Staff not to replace tubes. Call service provider. PPE must be worn.
Electrical - Potential for electric shock when cleaning electrical fittings and components	Electrically isolate cases before work is carried out. Staff training, RCD. Keep electrical connections dry at all times.
Falling - Climbing on shelves	Staff must be trained in OH&S procedures. MUST not climb on shelves or cases.
Crushing - Hands or fingers may become pinched or crushed during the positioning of base trays, shelves & stock	Staff must be trained in the correct procedures for setting up cases and ergonomic practices
Slipping - Drain may leak or become blocked causing water spillage	Visual Inspection and regular maintenance. Request service call when necessary.
Cuts and stabbing - Potential for cuts caused by damaged or missing parts	Visual Inspection and regular maintenance. Request service call when necessary. PPE must be worn when handling broken or damaged parts.
Ergonomic - Stretching during the cleaning of the case and positioning of stock and shelves leading to strains and sprains	Staff must be trained in the correct procedures for cleaning cases & ergonomic practices. Cleaning tools which reduce the need for stretching should be used.
Slipping - Surfaces may become slippery due to spillage from the case during operation or cleaning	Visual Inspection. Appropriate remedial action.
Cuts and stabbing - Potential for cuts caused by sharp edges & evaporator coil during cleaning	PPE must be worn by staff
Cuts and stabbing - Cleaning cold glass surfaces with hot water	Staff must be trained in the correct procedures for cleaning cases and ergonomic practices
Crushing - fingers, hands or body between doors	Operators to always open and close doors using handles provided, ensuring the area is clear of other persons.
Electrical - electrical connections in cases	Electrically isolate cases before work begins. Must be carried out by a service provider. Staff training.

Table 2:- Risk Analysis

Appendix 3 Warranty

The information in this manual is for “Qualified Persons Only”. It is **NOT** an Installation Guide for “**NON Qualified Persons**”.

To obtain warranty information or other support, contact your nearest Hussmann representative.

Please include the following:

- Customer site location.
- Cabinet model & serial number of product.
- Reason for warranty.