



# Vegetable Preparation Machine

**RG-400i**

Food Preparation Machines - Made in Sweden 



**60 kg /min**

**5000 /day**



hallde.com

# Unique Vegetable Preparation Machine in stainless steel



RG-400i is HALLDE's largest and most effective Vegetable Preparation Machine that prepares very large volumes, up to 5,000 portions/day or 60 kg/hour. The cutting tool range is broad; slices, dices, grates, shreds, cuts julienne, crimping slices and Potato chips in a wide range of dimensions. There is a broad range of feed attachments and accessories, enabling adaption to many different needs.

RG-400i is a floor model, with a compact shape, of high quality, manufactured in stainless steel, ergonomic and very easy to clean. The cutting tools, feeders and accessories can be cleaned in the dishwasher. RG-400i fulfils all of the requirements that are placed on a professional Vegetable Preparation Machine independent of which environment it is used in: restaurants, large sized kitchens, industrial environments, catering or as a part of a production system.

## Perfect cutting results

RG-400i has a broad range of cutting tools that slices, dices, grates, shreds, cuts julienne, crimping slices and Potato chips in a wide range of dimensions and prepares both hard and soft products. The cutting tool's large diameter of 215 mm in combination with the spacious feed cylinders means that RG-400i can handle high volumes at each fill. The rotation speed of the cutting tool is optimised to make even cuts as effectively as possible. The knives are ground according to purpose in order to retain their sharpness for a long time and are available as spare parts when it is time to replace them. The machine has two speeds - 200 rotations/minute and 400 rotations/minute.

## Best hygiene

All removable parts are manufactured in stainless steel and can therefore be washed in a dishwasher. The machine base, also in stainless steel, has smooth surfaces, rounded edges and lacks unnecessary recesses into which food can penetrate and get stuck. When the stainless removable tray is used, cleaning is facilitated even more because it can easily be taken out of the knife housing and cleaned in the dishwasher. In this way the machine base itself is kept free from the products that are being prepared. Thanks to the distance of 150 mm between the machine and the floor it is also easy to clean the floor under the machine. With help of the sturdy handle and the robust wheels on two of the machine's legs it is easy to move. RG-400i is manufactured solely of food approved material.

## A model safety system

In RG-400i there are two safety systems that prevent the machine from running when the cutting tool is unprotected. In order for the machine to start, the feed cylinder must be correctly mounted and the feeder must be in the right position and covering the cutting tool.

## Highest possible reliability

The powerful motor is developed to be able to handle long and tough preparation conditions when the machine is used constantly during full work days, for example in a production system and also for repetitive preparation with many starts/stops. RG-400i has a high torque during start and operation and drives the cutting tool via a maintenance free gear drive made completely of steel. Here there are no intermediate belts that can wear or break, all in order to ensure the highest possible reliability.





# RG-400i - when the demands on capacity are the greatest

RG-400i is HALLDE's largest and most effective Vegetable Preparation Machine that prepares very large volumes and can be advantageously integrated into a production system.



# Flexible preparation for all needs

Depending on what the machine will be used for a suitable type of feeder with associated cylinder and cutting tool are selected. All parts are easy to mount on and off, in just a few steps you will have replaced both the feeder and the cutting tool.

## Which feeder simplifies preparation for you?



### Reduced manual power with "Ergo loop"

The Manual Feeder can prepare all types of products, both large and small. The Ergo-loop design provides a lever effect that also reduces the need for manual force when preparing large and hard products, such as root vegetables, cabbage and cheese. For fast and safe preparation, the machine stops when the feeder is moved to the side and starts automatically when it covers the feeder cylinder's opening.



Manual Feeder



### Cut long and thin products vertically

To be able to easily cut long and narrow products vertically, and round products in a specific direction, the 4-Tube Insert is used. The feeder has four tubes with the following diameters: 73 mm (two tubes), 60 mm and 35 mm. The tubes provide good support for products in a range of different sizes, such as cucumber and leeks. It is also easy to "bunch" herbs and parsley, etc. together in the tube. When the 4-Tube Insert is used, the machine runs continuously because the rotating cutting tool is covered by the feeder at all times.



4-Tube Insert





Feed Cylinder A with three internal knives fixes and divides up the product during preparation and is used for the Pneumatic Push Feeder, Manual Feeder and 4-tube Insert. It is optimal for preparation of cabbage.



Feed Cylinder B with one internal wall is used for the Manual Feeder and 4-tube Insert. It is optimal for manually orienting of products, stacking.



### Minimise workload and save time

The Pneumatic Push Feeder can prepare all types of products, both large and small. With the pneumatic feeder the product is pushed down automatically with just one push of a button. The workload and time spent are minimised and the feeder is therefore particularly advantageous when preparing larger quantities and when large and hard products are to be cut. Just as with the Manual Feeder the cutting tool stops rotating when the feeder is moved to the side and automatically starts again when the feeder is swung back. The Pneumatic Feeder has three speeds that can be varied depending on what is going to be prepared.

**Pneumatic Push Feeder**



### Continuous, filling by the bucket load

The Feed Hopper enables continuous filling by the bucket load for preparation of primarily round products. Capacity is very high because the machine runs continuously and is therefore extremely time-efficient. The RG-400i with a Feed Hopper can be beneficially included in a continuous production flow.

The feed cylinder for the Feed Hopper is designed with two feed compartments that press the product down against the cutting tool during preparation.

**Feed Hopper**

# Accessories that simplify kitchen life



## Accessory Trolley for practical storage

The accessory trolley offers practical storage of accessories and cutting tools. It has space for three feeders and both feed cylinders. Cutting tools can be hung on the trolley in order to provide free space and avoid unnecessary wear. The accessory trolley is the ideal aid for keeping the tools neat and tidy for fast and easy handling and storage. The trolley is made entirely of stainless steel and has sturdy wheels, two of which are lockable.



## Stainless steel Container Trolley for a smooth flow

The stainless steel Container Trolley is placed in front of the Vegetable Preparation Machine during preparation in order for the ready cut products to be easily transported further in the preparation process. The trolley includes a 1/1-200 gastronorm container. The frame that holds the container can be adjusted at different heights and can even be folded up completely, which means that it is perfect for use in for example transporting sacks of potatoes, cabbage or onions. The trolley is made entirely of stainless steel with four sturdy wheels, two of which are lockable.



## Tray for preparing diced foods and French fries

- also facilitates cleaning

In order to simplify cleaning the tray is placed in the bottom of the machine base, which is then kept free from the product that is being prepared. When the preparation is complete, simply remove the stainless steel tray from the machine and clean it in the dishwasher. The need for cleaning the machine base by hand is thus minimised, all for the best hygiene.

The tray is always used when preparing products using the Dicing Grid or French Fry Grid. This is also recommended when preparing products using other cutting tools.



## Compressor for the Pneumatic Push Feeder

When using the Pneumatic Push Feeder, precisely as the name indicates, you need compressed air. If the property where the machine is going to be used does not have compressed air, HALLDE offers a compressor in its accessory range. The compressor is silent (below 64 dBA) and mounted on a trolley so it is easy to move.



## Practical wall rack for cutting tools and Cleaning brush

The wall rack has space for three cutting tools. It is easily mounted on the wall and provide a quick overview of the entire range, saves space and makes handling safe and comfortable. At the same time it is an effective way to protect the edges of the knife blades from unnecessary wear.

















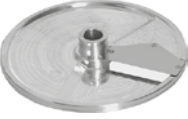









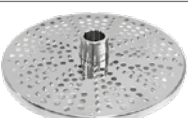

Cleaning brushes in two sizes for cleaning machines and cutting tools. Both have coarse bristles that are particularly effective for cleaning dicing grids and julienne cutters.

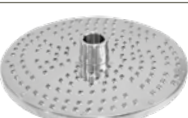

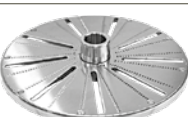
# High quality cutting tools for best results



All cutting tools are dishwasher safe. \* = Stainless Steel. HC = High Capacity

	<b>Slicer</b> * 0.5, 1, 1.5, 2, 3, 4, 5, 6, 7, 8, 9, 10 mm.	Slices firm and soft vegetables, fruits, mushrooms etc. Dices when combined with a suitable Dicing Grid. Cut French fries in combination with Potato Chip Grid.	
	<b>HC Slicers</b> 2, 3, 4, 6, 8, 10, 12, 15, 20 mm.	Slices hard vegetables and fruits, and dices when used with the recommended dicing grid. Cuts potato chips when used with the Potato Chip Grid. HC Slicers have double blades and, accordingly, high capacity.	
	<b>Fine Cut Slicer</b> 14, 20 mm.	Slices firm and soft vegetables, fruits, mushrooms etc. Dices when combined with a suitable Dicing Grid.	
	<b>Soft Slicer</b> 8, 10, 12, 15 mm.	Slices soft vegetables, fruits, mushrooms etc. Preferably used when dicing soft products, in combination with a suitable Dicing Grid.	
	<b>Crimping Slicer</b> * 3, 4, 5, 6 mm.	Cuts decorative rippled slices of beetroot, cucumber, carrots, etc.	
	<b>HC Crimping Slicer</b> 2, 3, 4, 6 mm.	HC Crimping Slicers have double blades and, accordingly, higher capacity. Cut decorative rippled slices of beetroot, cucumber, carrots, etc.	
	<b>Julienne Cutter</b> * 2x2, 2x6, 3x3, 4x4, 6x6, 8x8, 10x10 mm.	Cuts julienne of firm products for soups, salads, stews, decorations etc. Suitable to cut slightly curved potatoes chips.	
	<b>HC Julienne Cutter</b> 2x2, 2.5x2.5, 2x6, 4x4, 6x6, 8x8, 10x10 mm.	Produces Julienne cuts of solid produce for soups, salads, stews, garnish, etc. Suitable for cutting potato chips. HC Juliennes has double blades and, accordingly, high capacity.	
	<b>Grater/Shredder</b> * 1.5, 2, 3, 4.5, 6, 8, 10 mm.	Grates carrots and cabbage for raw salads. Grates nuts, almonds and dry bread. Grater 6 or 8 mm is commonly used for grating cheese for pizza and when shredding cabbage.	
	<b>Fine Grater</b> * 1.5, 2, 3, 4.5, 6, 8, 10 mm.	For finely grating products, from hard/dry cheeses, raw potatoes for Swedish potato pancakes and bread for making breadcrumbs.	
	<b>Hard Cheese Grater</b> * 1.5, 2, 3, 4.5, 6, 8, 10 mm.	Ideal for grating hard cheese such as parmesan. Produces a somewhat coarser grate than the Fine Grater, Extra fine.	
	<b>Fine Grater, Extra fine</b> * 1.5, 2, 3, 4.5, 6, 8, 10 mm.	Grates products very finely, such as black radish grated for purée and potatoes for mashing.	
	<b>Dicing Grid</b> * 6x6, 8x8, 10x10, 12x12, 15x15, 20x20, 25x25 mm.	Cuts dices in combination with a suitable type of slicer. Dice both hard and soft vegetables, fruits etc.	
	<b>Potato Chip Grid</b> * 10x10 mm.	Cuts potato chips in combination with Slicer 10 mm, HC Slicer 10 mm or Soft Slicer 10 mm.	

Take a look at the results- and inspiration videos at our homepage, [hallde.com](http://hallde.com)





### Machine

- Motor: 1.5/0.9 kW. Two speeds (200 and 400 rotations/minute) 208–440 V, 3-phase, 50–60 Hz.
- Transmission: Maintenance free gear drive.
- Safety system: Three safety breakers.
- Protective class, machine: IP45.
- Protective class, push buttons: IP65.
- Wall connection: Earthed, 3-phase, 16 A.
- Sound level LpA (EN31201): 70 dBA.
- Magnetic field: Less than 0.4 microtesla.

### Material

- Machine housing: Stainless steel
- Feed cylinders: Stainless steel
- Feeders: Stainless steel
- Cutting tool discs: Stainless steel/ Aluminium.
- Cutting tool knife blades: Stainless knife steel.

### Feeders

Four different feeders:

- Manual Feeder with ErgoLoop gives a lever effect.
- Pneumatic Push Feeder: three speeds.
- 4-tube Insert: Diameter 73 mm (2 tubes), 60 mm and 35 mm.
- Feed Hopper: Volume approx. 23 litres. Height 350 mm. Diameter 420 mm.

Three types of feed cylinders:

- Volume 9 litres. Height 250 mm. Diameter 200 mm.
  - Feed cylinder A with three internal knives for the Manual Feeder, Pneumatic Push Feeder and 4-tube insert.
  - Feed cylinder B with one internal wall is for the Manual Feeder, Pneumatic Push Feeder and 4-tube insert.
  - Feed cylinder for Feed Hopper has two internal feed compartments.

### Cutting tool

- Diameter: 215 mm.
- Rotations count: 200 and 400 rotations/min.

### Type of preparation

- Slices, dices, grates, shreds, cuts julienne, crimping slices and potato chips.
- Prepares fruit, vegetables, dry bread, cheese, nuts and mushrooms.

### Users

- Restaurants, retail, pizzerias, central kitchens, institution kitchens, schools, hospitals, food processing industries, fast food outlets, ships, catering kitchens, etc.

### Net weight

- Machine base: 63 kg.
- Feed cylinder: 6 kg.
- Manual Feeder: 7.5 kg.
- 4-tube insert: 5 kg.
- Pneumatic Push Feeder: 12 kg.
- Feed Hopper with feed cylinder: 12 kg.
- Cutting tool: 1 kg.
- Tray: 1.5 kg.

### Standards

- Directive: Visit [Hallde.com](http://Hallde.com) and select product and Certification.

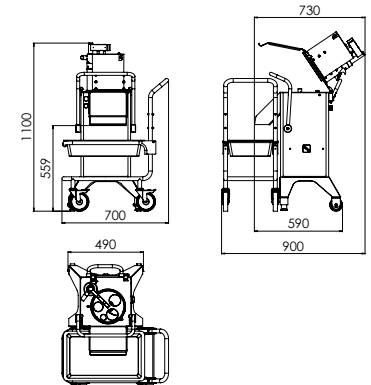
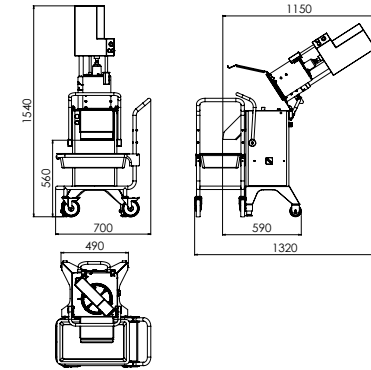
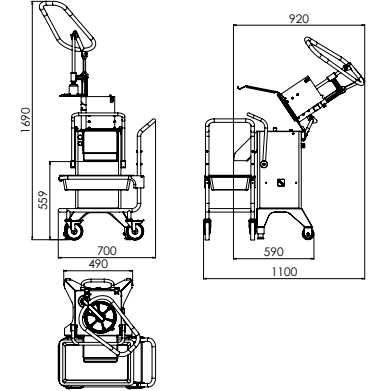
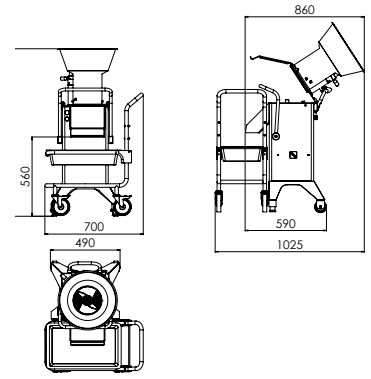

Food Preparation Machines  
Made in Sweden

AB Hällde Maskiner P.O.Box 1165 SE-164 26 Kista Sweden  
• Phone: +46 8 587 730 00 • Fax: +46 8 587 730 30 • [hallde.com](http://hallde.com) • [info@hallde.com](mailto:info@hallde.com)