

User Guide

Thank you for purchasing a SKOPE refrigeration product.

Safety

Always observe safety precautions when using any electrical appliance. Read these instructions carefully and retain them for future reference.

WARNING

- Ensure the appliance is disconnected from the power supply before performing any cleaning or maintenance.
 - Do not cover the grilles or block the entry or exhaust of airflow by placing objects up against the refrigeration unit.
 - Should manual defrosting be necessary, turn off the refrigeration system and allow the ice to melt by air circulation. Collect ice and water during defrost to prevent a slip hazard. Do not use mechanical methods to remove ice, as this may damage the refrigeration circuit.
 - Do not use any electrical devices or appliances inside the food storage compartment.
-
- This appliance is not intended for use by persons (including children) with reduced physical, sensory or mental capabilities, or lack of experience and knowledge, unless they have been given supervision or instruction concerning use of the appliance by a person responsible for their safety. Children should be supervised to ensure that they do not play with the appliance.
 - Do not use this appliance for other than its intended use.
 - Do not insert fingers/foreign objects into any holes.
 - Only use this appliance with the voltage specified on the cabinet rating label.
 - Ensure the appliance has adequate ventilation as this is essential to economical, high performance.
 - Be careful not to touch moving parts and hot surfaces.
 - For your own safety and that of others, ensure that all electrical work is done by authorised personnel.
 - If the power supply flexible cord becomes damaged, it must be replaced by an authorised service agent or similarly qualified person in order to avoid a hazard.
 - Ensure all necessary safety precautions are observed during installation or removal of the refrigeration unit.
 - The appliance is not designed to be stable while in motion. Use extreme caution when moving or transporting it.
 - Do not store explosive substances such as aerosol cans with a flammable propellant in this appliance.
 - Do not exceed a maximum load of 20kg per shelf.
 - If the cabinet is to be scrapped, ensure the cabinet is unplugged from the power supply and cut off the mains flex close to the back of the cabinet. Be mindful of the risk of animals or children becoming trapped in the appliance – either remove or secure doors if necessary.
 - Refrigerant must be removed by a qualified service person and the cabinet recycled/disposed of in accordance with local regulations.

This cabinet is designed to operate within a specific climatic class environment. See the cabinet rating label inside the cabinet for climate class number.

Climate class	Ambient temperature	Relative humidity
3	25°C	60%
4	30°C	55%
5	40°C	40%
7 (tropical)	35°C	75%

The cabinet includes relevant hazard symbols that may be associated with the cooler. Refer to the information below for symbol description.



WARNING

The refrigeration system contains flammable R290 refrigerant. Do not tamper with it.

The refrigeration system must only be serviced by qualified personnel.

ReFlex Salad and Pizza Preparation Fridge



Installation Guidelines

Ensure the installation guidelines below are considered and met.

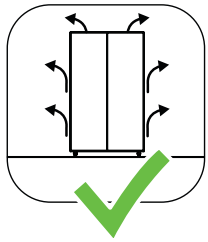

Ventilation

Ensure all ventilation requirements below are met.

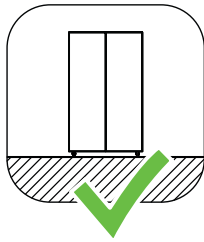

Surface

The installation surface must be capable of supporting the loaded cabinet.

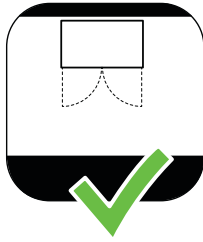

Door Opening

Allow adequate space for the door/s to open and close properly.

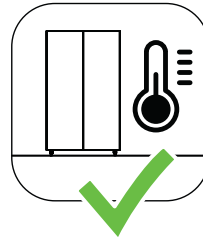

Climate Class

The cabinet must be installed in an environment within its climate class.

The climate class is stated on the cabinet rating label inside the fridge, and explained on the front page of this user guide.

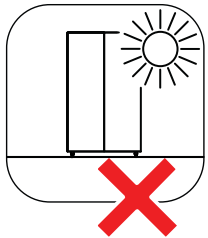
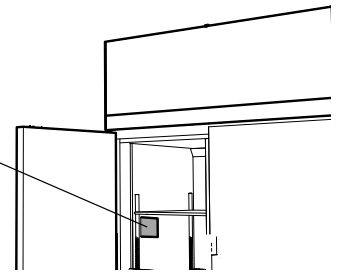

Sunlight

Do not install the cabinet in direct sunlight.

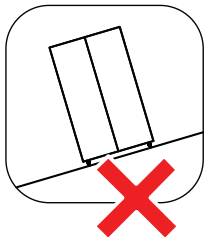

Uneven Surface

Do not install the cabinet on an uneven surface.

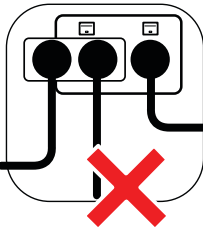

Power Supply

Do not overload the power supply.

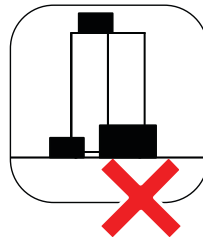

Blocking Ventilation

Do not store boxes or items in front or on top of the cabinet.

Ventilation and Clearance Requirements

This cabinet must have the following ventilation clearances at all times:

190mm (salad) and 420mm (pizza) above clearance required (for cover opening)

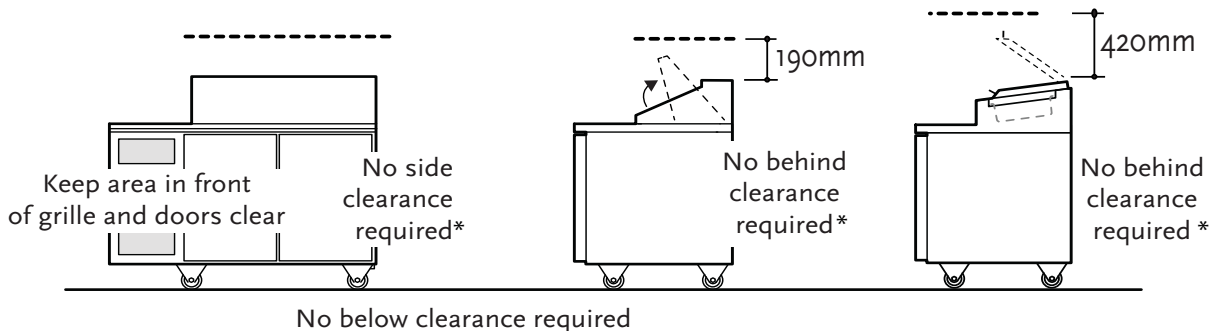

*When operated in recommended conditions.

Cleaning Before First Use

The cabinet interior and food contact surfaces such as the worktop must be thoroughly cleaned and sanitised before first use. Ensure the cabinet is unplugged from the power supply before cleaning, and use only standard stainless steel cleaners suitable for food preparation areas. If required, the cabinet exterior can be cleaned as instructed on the back page of this user guide.

Power Cord

Before final positioning of the cabinet, pull the power cord out and connect to the power supply.

ReFlex Salad and Pizza Preparation Fridge



Shelves

Each shelf is held in place with four shelf clips, which clip into the shelf support strips. The shelf clips may be positioned at different heights to suit various product.

Food Preparation Pans and Cover

The cabinet is supplied with GN 1/3 – 100mm deep food preparation pans and pan dividers. The cabinets are also compatible with the following pan dimensions (not supplied): GN1/3 – 150mm deep; GN1/6 – 100mm deep; GN1/6 – 150mm deep. The pans and pan dividers fit into openings on top of the cabinet. The cabinet is also fitted with a hinged cover that closes over the pan area.

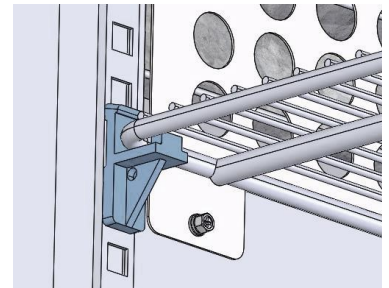

Operation

IMPORTANT: For correct operation of the cabinet:

- The maximum operating ambient temperature for salad and pizza cabinets is 40°C.
- Keep pans in place to help with air circulation. Use the pan dividers to ensure there are no gaps between the pans.
- Keep the hinged lid closed to cover the food preparation containers when not in use.
- The integrated hood and hinged lid are critical to achieve food-safe performance of this cabinet. Removing these components will affect performance and therefore, should they be removed or modified, we cannot guarantee cover-free, food-safe operation in the well.
- If you or your supplier choose to remove the hood and lid, we strongly recommend you use an equivalent cover over the well at all times to maintain temperatures below 5°C. It is important to ensure that any such cover does not impede the operation of the air flow over the pots.

Performance

- This cabinet will hold food in the well at under 5°C with the lids closed at maximum 40°C ambient temperature.
- This cabinet will hold food in the well at under 5°C with the lids open at maximum 30°C ambient temperature for up to 4 hours, subject to suitable installation according to our instructions. However, if the lids are open for more than 4 consecutive hours at the recommended operating temperature, performance may be compromised.





Condensation/Evaporator Tray

Open refrigeration cabinets generate significantly more condensation than fridges with doors. The hotter and more humid the conditions the more condensate an open cabinet will generate. As a result, condensate trays may not be able to evaporate all excess moisture for open units in heavy use environments or challenging climate conditions.

- In rated conditions where the lids are not open for more than 4 hours of every 24, the condensate tray is sufficient to evaporate the condensation.
- For hot and high humidity conditions SKOPE recommends plumbing prep cabinets into drains.

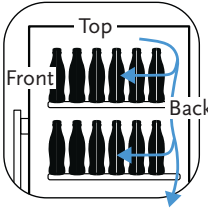
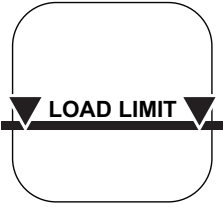
Loading product

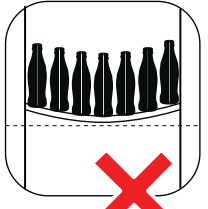
Let the cabinet cool down to the desired storage temperature before loading it with product. When loading the cabinet:

					
Internal Airflow Leave 25mm space between product and the back of cabinet interior	Load Limit Do not load product above the load limit indicators	Shelf Loading Do not overload the shelves	Shelf Flexing Remove product if the shelf is flexing	Shelf Overhang Do not let product overhang the shelves	Cabinet Floor Do not load product on the cabinet floor. Use the shelves.

ReFlex Salad and Pizza Preparation Fridge



Electronic Controller

The electronic controller regulates the cabinet internal temperature, signals alarms and captures operational information. The internal temperature is factory set for storage of perishable product.

To customise the settings to your requirements and view historical data, download the SKOPE-connect app from the Google Play Store or Apple App Store, and connect via **Bluetooth®** wireless technology.



Door Lock/s

The cabinet is fitted with key locks, which can be unlocked with the supplied key(s).

Lights

The interior lights switch on and off automatically depending on use.

Routine Cleaning

Ensure the cabinet is unplugged from the power supply before cleaning.

IMPORTANT: Do **NOT** use abrasive, corrosive or solvent-based cleaners, as this could damage the protective coating on the door exterior.

Wipe the outside of the cabinet with a damp cloth, and the inside of the cabinet with standard stainless steel cleaners suitable for food preparation areas. Take care to keep moisture away from electrical parts.

For optimum hygiene, thorough and frequent cleaning of all areas/components is required. For easy cleaning access, the pots, dividers and well duct components are easily removed replaced without tools. For periodic deep clean cycles, the pot well is fully removable (tools required).

The condenser coil must be kept clean. SKOPE strongly recommends monthly cleaning of the condenser coil and air filter. Do **NOT** use hard or sharp tools to clean the coil as these may cause damage.



Clean filter

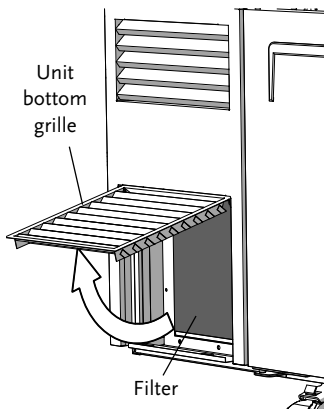

1. Unplug the cabinet from the power supply.
2. The filter is located behind the unit bottom grille, and attached using magnets. Remove the filter from the cabinet.
3. Clean the filter with a vacuum cleaner, wa with cold water, and shake off any excess water before refitting. do **NOT** apply hot water, blow-dry, or place in a dishwasher. If necessary, discard and refit a new filter.

Clean coil

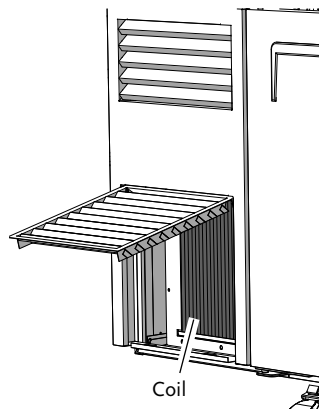

4. With the cabinet unplugged from the power supply, and the filter removed (see previous steps), brush the condenser coil with a soft brush to remove any dust or fluff.
5. Refit the filter, close the bottom grille, and reconnect to the power supply.

Service & Support

We know you will get years of satisfaction from your new SKOPE product when you follow a few simple preventative maintenance guidelines.

Helpful information is available on the SKOPE website www.skope.com/serviceandsupport

