

Speed S +plus

DESIGNED FOR EFFICIENCY

zumex[®]
LIFE ESSENCE





Speed Pro and Speed S^{+plus}

THE MOST COMPLETE SERIES

The key factors of the Speed series are speed and capacity. With its unique juice extraction and professional service, it has consolidated its position as a key product in several different industries.

Discover the **tabletop** and **podium** models and see how they can be adapted to day to day use in large superstores and self service areas.

Objective: Get the best performance.



The 6 key factors to the success of Speed

From beginning to end, everything is taken care of to make your life easier.

20 Kg



1 Improved loading

- 20 kg capacity.
- Easy action front opening.
- Guaranteed orange rotation.
- **Drain&Clean** system, for better cleaning.



2 Easy action juice extraction unit

- Wide feeder tube, which makes it easier to put oranges into the machine.
- An easy to remove cover with extraction system **Click&Clean**.
- Peel outlet with automatic safety stop detectors.



3 Self-service!

- **2Service tap** with two modes: continuous or non-continuous, perfect service, intuitive and functional.
- Removable, easy to clean.
- Removable stainless steel bin "in just one click".



4 PulpOut system

- **Manual sweeper:** slide side-to-side and eliminate the pulp when you need to.
- **W Filter:** traditional way of removing pulp; empty-out when ready.



5 Intelligent Electronics

- The **Intelligent Touch** device can be used to programme the usage mode (automatic or professional), the language, and the number of oranges to be squeezed.
- **Waste Limit:** it is possible to programme in the load capacity so that the machine will stop automatically when the waste bucket is full.



6 Waste management

- Stainless steel podium with wheels which improves mobility and security.
- 52 L capacity waste trolley.

More juice
in less time.



New automatic PulpOut system
High performance

01



New 1Step Extraction Kit
Disassemble and clean in record time

02



New tap
Greater ease of service

03

NEW

Speed S^{+plus}

New models for enhanced possibilities

Discover the new Speed S^{+plus} models which provide a more efficient, secure and faultless service than ever before.

The new Speed S^{+plus} has been created for cafeterias, supermarkets and hotels. It offers an improved user experience and is faster and easier to use.

Speed S^{+plus} expands the possibilities for your business. Discover the new models.

Speed S⁺plus

SQUEEZE THE MOST OUT OF YOUR SUPERMARKET

More features to satisfy high juice demands

Our daily life usually leaves us with little time to look after ourselves and eat and drink healthily.

A competitive advantage.

This is why more and more supermarkets are offering their customers freshly squeezed, high quality juice in their stores.

This is possible with the new range of Speed S⁺plus juicers.

Functional and easy to use.

Prepared then and there by the consumer, you can offer the freshest supermarket product to take away or to drink then and there.

Choose the best option for your supermarket. There's a Speed S⁺plus for every situation.



Speed S⁺plus
Self Service Podium



Speed S⁺plus
Self Service



Speed S⁺plus
Tank Podium



Discover the next level

We are reaching new heights with the Speed S ^{+plus}. Here are the new features which make it an extraordinary juicer.

It's now even easier to get the best juice. Perfect for **supermarket chains, hotels or self service stores** that are looking for a better level of service.

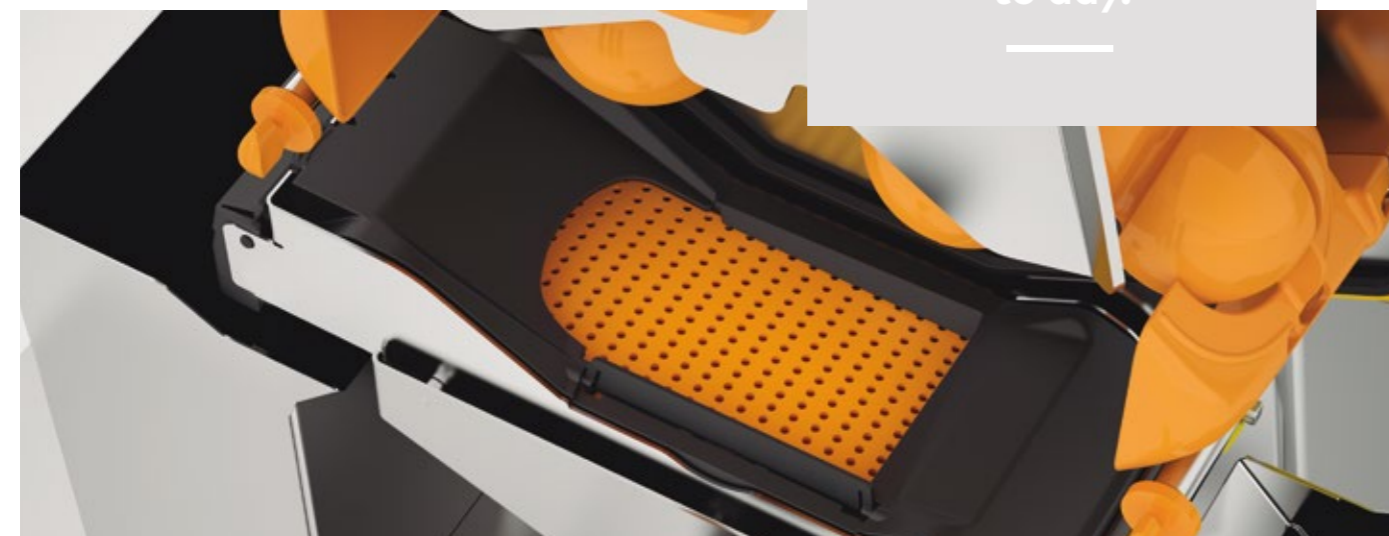

More benefits, better hygiene and easier to use, better value for you from day to day.

Triple filter

Guaranteed high quality and optimal texture juice.



New automatic PulpOut system

High performance

Its automatic conveyor belt which gets rid of pulp **easily, hygienically and quickly**. It saves time and means your juicer can run by itself.

You can programme the machine's usage mode, **continuous or non-continuous** which will improve your juicer's performance and the **Autoclean function** will always keep the filter clean

You choose!

Modes:

- **Continuous. Maximum autonomy.** Eliminates pulp during all of the juicing time.
- **Non-continuous. To maximize filtering time.** The number of juicing cycles can be set according to the type of pulp.

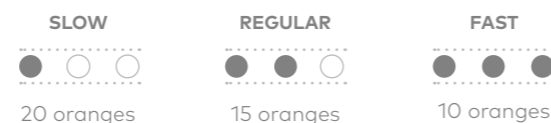

- **Autoclean function.** This will get rid of the pulp once juicing is finished. And keep the filter clean to maintain your self-service store's good image.



Quick disassemble

This will get rid of the pulp once juicing is finished. And keep the filter clean to maintain your self-service store's good image.



High precision filter maximises performance

The micro-perforated silicone pulp conveyor belt improves performance by producing more juice per orange.



Great engineering design

The top cover directs the juice to the centre of the belt to better remove the pulp. The side cover stops the remaining pulp from falling.



Dishwasher friendly

All components can be cleaned in the dishwasher.

Disassemble
and clean
in record
times

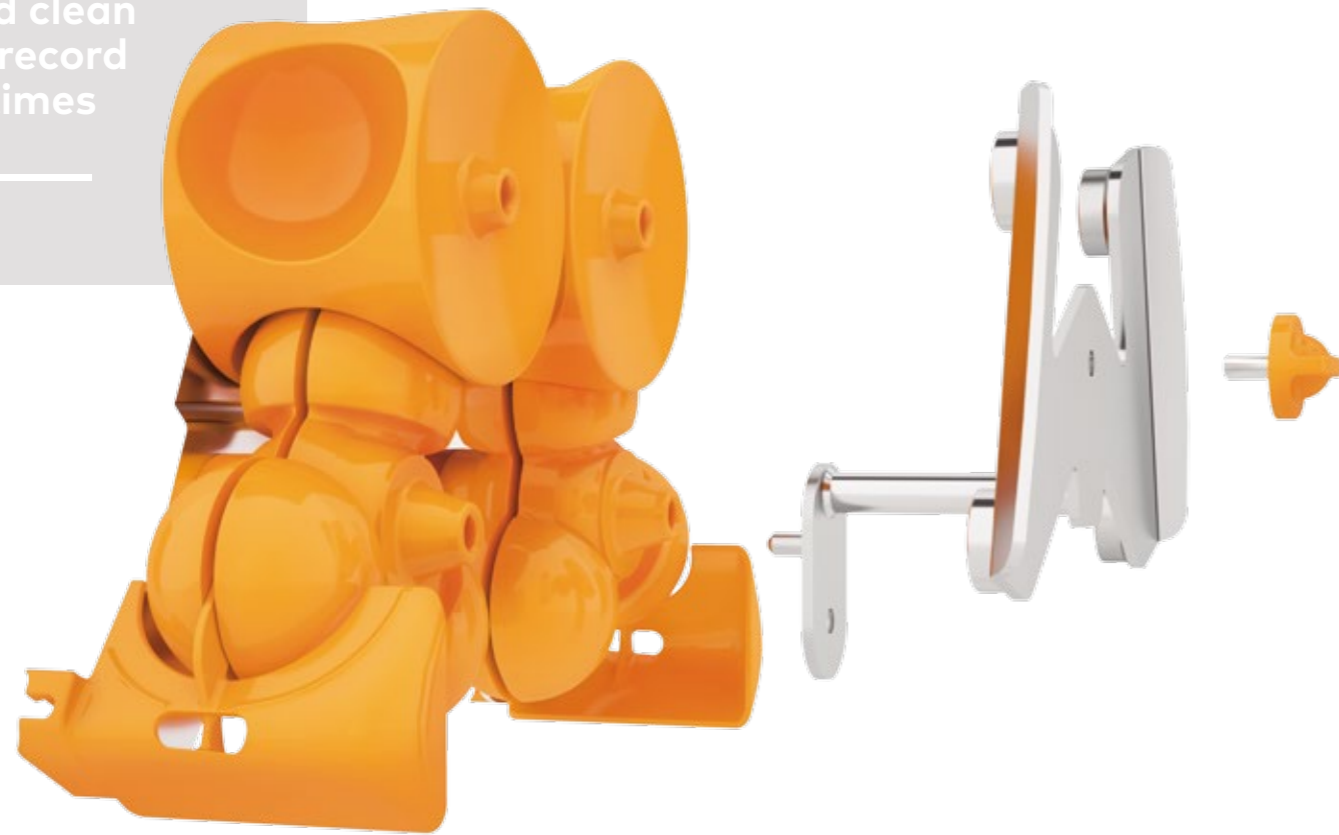

New 1Step Extraction Kit

for those that
need a Plus

- **A Kit for the fastest**

Removing the juicing mechanism is easy and fast. Turn the central knob and remove the entire juicing mechanism in just one move.

- **New design, less pieces**

The new ergonomic W-shaped stainless steel support is designed to make things easier. It also has less parts to guarantee improved hygiene and easy cleaning.

The juice extraction process can be visualised, avoiding splashes.

- **Easy cleaning**

The mechanism can be cleaned in one piece, in a dishwasher or under the tap.

*A deep clean is recommended at least once a week.

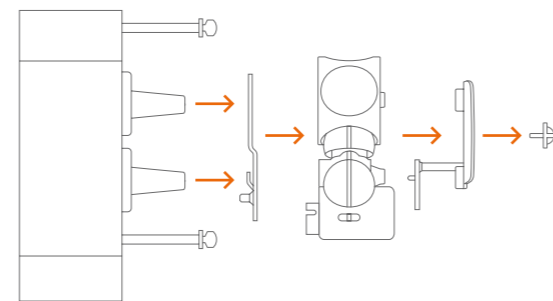

Easy disassemble.



Drip tray with waste spout to waste bin.

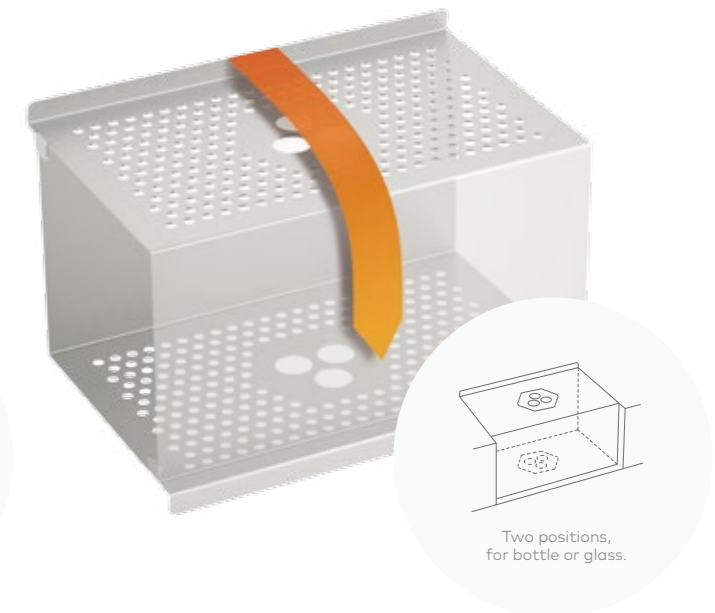

Two positions, for bottle or glass.



up to
50 L
20 Kg

per compartment

New tap and tray

Easy serve

New **tap with bottle support and front tap** to serve the juice in a bottle at the push of a button.

It also has a **new 2-position drip tray** so you can offer the possibility of pouring directly into a glass.

Comes as standard with the Speed S^{+Plus} Self Service Podium.

New podium

Double capacity

The new podium has two compartments which can take up to 100 L - 40 Kg of waste. Which means it can juice up to **70 Kg / 500 oranges** without being changed.

It drains directly into the waste bin, affording easy cleaning and autonomy.

In Speed S^{+Plus} Self Service Podium model.

disassemble
10"



Patent: P201731239

Speed Pro and Speed S^{+plus} details

Robust on the outside. Fast on the inside

Technical Characteristics	
Fruits per minute	40 oranges / min
Litres per minute	2.5 - 4.5 l / min
Fruit size	65-81 mm
Feeder capacity	20 Kg 44 lb
Specification	IPX4

Power	300 W 0.4 HP (560 W 0.75 HP Cooler)
Consumption	2.7 A (4.85 A Cooler) / 1.2 A (2.4 A Cooler)
Voltage	120 V 60 Hz / 220-240 V 50-60Hz
Security	Triple safety detector and motor seizure detection

Your choice of Speed model will depend on how it will be used.



Speed Pro Basic

Model indicated for restaurants with a high juice demand due to its capacity and easy cleaning. Ideal for your convenience.



Speed Pro Self Service

It is characterised by its adaptability to restaurants, self-services and hotel buffets. It revolutionizes the Self-Service world.



Speed Pro Self Service Podium

The perfect option for supermarkets thanks to its tap, simple operation and functionality.



Speed Pro Tank Podium

Perfectly suited to retail establishments with room. Its 5 litre storage tank which keeps juice fresh and instantly ready.

Dimensions (WxDxH)	59.3 x 57.4 x 98.9 cm 23.3" x 22.6" x 38.9"
Net weight	64.7 Kg 142.4 lb

Dimensions (WxDxH)	59.3 x 65.8 x 105 cm 23.3" x 25.9" x 41.3"
Net weight	72 Kg 159.4 lb

Dimensions (WxDxH)	67.5 x 70 x 176.5 cm 26.6" x 27.6" x 69.5"
Net weight	120 Kg 262.8 lb

Dimensions (WxDxH)	67.5 x 70 x 176.5 cm 26.6" x 27.6" x 69.5"
Net weight	119 Kg 262 lb



Speed Pro Cooler Podium

Freshly squeezed and refrigerated juice, ready to drink. With temperature-controlled cooling device, 7-litre (1,85 gal.) tank and level detector.



Speed S^{+plus} Self Service

The new Speed S^{+plus} Self Service with automatic PulpOut system and 1Step Extraction Kit, is configured to give more autonomy and to ease cleaning.



Speed S^{+plus} Self Service Podium

Comes with automatic PulpOut system, 1Step Extraction Kit and new podium, perfectly suited for those who need to produce a large quantity of juice.



Speed S^{+plus} Tank Podium

Has all of the new features of the Speed S^{+plus} while also having the advantage of a juice tank.

Dimensions (WxDxH)	67.5 x 72.7 x 185 cm 26.5" x 28.6" x 72.8"
Net weight	128 Kg 282.2 lb

Dimensions (WxDxH)	59.3 x 67.5 x 105 cm 23.3" x 26.6" x 41.3"
Net weight	74 Kg 163.8 lb

Dimensions (WxDxH)	80.5 x 70.4 x 177.6 cm 31.7" x 27.7" x 69.9"
Net weight	125.1 Kg 276 lb

Dimensions (WxDxH)	67.5 x 70 x 176.5 cm 26.6" x 27.6" x 69.5"
Net weight	121 Kg 266.7 lb

Your bespoke Speed Pro and Speed S^{+plus}

Create your perfect juicer



Kit S

For smaller diameters

Perfect to squeeze smaller fruit, from 45 mm to 67 mm, such as small oranges, tangerines and limes.

*For Speed Pro models.



Kit L

For larger fruits

Perfect to squeeze larger fruit, from 75 mm to 95 mm, such as large oranges and grapefruits.

*For Speed Pro models.



Zumex Pack

Juice to take away

Take away freshly squeezed juice to drink wherever you like, our bottles come in 6 sizes (1.5 l, 1 l, 75 cl, 50 cl, 33cl y 25 cl) all with personalised labels.



Bottle Rack

For when the machine is being used in a self service setting

This takes the worry out of organising your bottles, glasses or jugs clearly and will impress your clients.



N

1Step Extraction Kit S

Extraction Kit including Kit S juice extraction system

For faster and clean extraction of the Kit S.

*Coming soon for Speed S^{+plus} models.

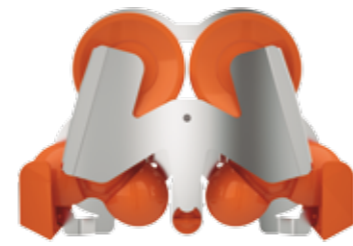

N

1Step Extraction Kit L

Extraction Kit including Kit L juice extraction system

For faster and clean extraction of the Kit L.

*Coming soon for Speed S^{+plus} models.

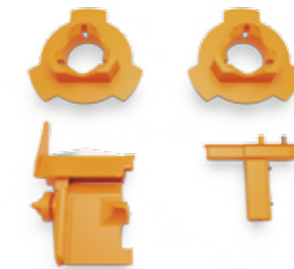

DCS System

For the trickier fruit

Dynamic blade Kit to juice soft or over ripe citrus fruit.



Countertop Kit

So that the machine can run by itself

Waste management is integral to this system and this will help you do it in the cleanest, most practical way.

Speed Pro Basic, Speed Pro Self Service and Speed S^{+plus} Self Service models.



N

1Step Extraction Kit

Discover how to keep your Speed S^{+plus} juicer running at its best

Obtain your 1Step Extraction Kit with additional juice extraction system and start to save time now. With this accessory you will be able to dismantle the machine in just 10 seconds and leave your machine ready to start working with the other Kit.

*Accessory available for all Speed S^{+plus} models. Including juice extraction system.



Large Zumex Display (including drain system)



Small Zumex Display (including drain system)

Display Unit

Cool your juice!

So that you always have your bottles of freshly squeezed juice ready to take away. Available in two sizes.



Zumex Group, S.A. Headquarters

Polígono Ind. Moncada III
C/ Moli, 2 46113 Moncada, Valencia, Spain
Tel. +34 961 301 251 Fax.+34 961 301 255
zumex@zumex.com

Zumex USA Inc. USA & Canada

1573 NW 82nd Ave, Miami, FL 33126 USA
Tel. +1 305 591 0061 Fax. +1 305 591 0062
Technical Assistance:
1-877-ZUMEX-TA (+1 877 986 3982)
zumexusa@zumex.com

Zumex México

Uxmal 616, Colonia Vértiz Narvarte
Delegación Benito Juárez
CP 03600 Ciudad de México, México
Tel. +52 (55) 5212-0619
zumexmexico@zumex.com

Zumex UK

3 More London Riverside
SE1 2RE London, United Kingdom
Tel: +44 20 3519 1292
zumexuk@zumex.com

Zumex France

45 rue de Villeneuve
94573 Rungis Cedex, Paris, France
Tel: +33 975 187 354
zumexfrance@zumex.com

Discover a higher level
on our website

www.zumex.com

Patent: P201731239



En
07953