



# AARMG.12 GRIDDLES



Model shown with optional equipment stand

PROJECT \_\_\_\_\_  
 ITEM \_\_\_\_\_  
 QUANTITY \_\_\_\_\_  
 DATE \_\_\_\_\_

The Griddle Series is designed for heavy duty use and performance. All the latest technology is incorporated to provide the best value for money.

Quality, dependability and customer satisfaction make American Range the ultimate choice.

**FEATURES & BENEFITS:**

- Highly polished 19mm steel griddle plate, 533mm cooking depth
- Stainless steel front and sides
- Compact design for countertop use or with an optional stand
- Removable grease drawer
- Griddle burner – Piezo ignition with pilot

**TECHNICAL DATA:**

**Dimensions (W x D x H):** 305 x 828 x 437 (1137)\*  
**Total Weight:** 52 Kg  
**Griddle:** 305mm wide, 19mm thick  
 21MJ/Hr Griddle Plate

GAS DETAILS	Natural Gas (NG)	Universal LP Gas (ULPG)
Minimum Supply Pressure	1.13 kPa	2.75 kPa
Operating Pressure	1.0 kPa	2.49 kPa
Total Gas Supply	21MJ/Hr	19MJ/Hr

3/4" BSP connection

**OPTIONAL EXTRAS:**

- 102mm adjustable legs
- Equipment stand
- Castor kits
- 25mm thick Griddle Plate upgrade

\*Height on optional stand

**NOTE:** It is the responsibility of the installing gas plumber to ensure correct supply and connection sustaining appropriate pressure when all appliances are full on.

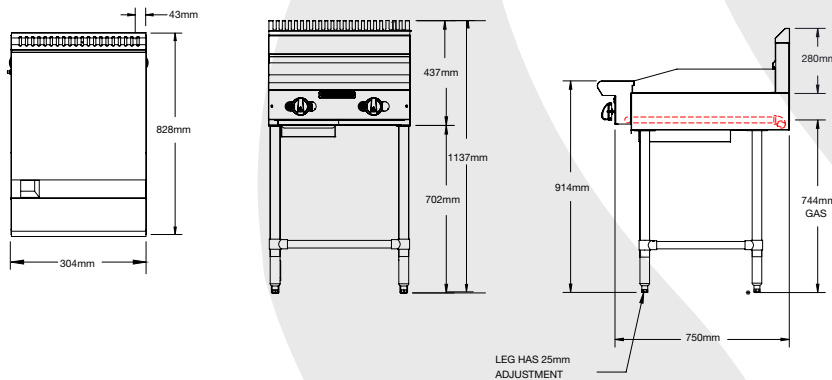

**NOTE:** 25mm thick griddle plate available. Contact your local Stoddart Representative for more information.

Due to continuous product research and development, the information contained herein is subject to change without notice.  
 Revision: 15/8/2019