



Adjustable thermostat for accurate temperature maintenance

Powerful fan for even circulation of cold air

Metal door frame for durability and reliability (display units only)

Large illuminated display for maximum impact

Self-closing doors minimise temperature loss

Double-glazed (chillers) or triple-glazed (freezers) safety glass doors increase energy efficiency

High-density polyurethane insulation keeps temperature and energy consumption low

Adjustable shelving for flexibility in display configuration (excluding static freezers)

High-impact internal lighting for perfect product presentation

Lockable castors make movement and placement easy

Bromic's Vertical Display & Storage range offers complete versatility, available in one-, two- and three-door configurations across a wide range of temperatures and styles.

13. Upright Display Chillers & Freezers:

Bromic's Upright Display Chillers and Freezers offer reliability in a stylish casing, creating display solutions suited to self-service retail applications.

These dependable units achieve exceptional efficiency while maintaining longevity through simplicity.



16. LCD Video Chiller:

Bromic's LCD Video Chiller introduces exciting movement to point-of-sale marketing, demanding the attention of customers by overlaying refrigerated products with relevant advertisements or imaginative entertainment.

This unit's 50-inch LG Ultra High Contrast LCD display resides within a double-glazed door and is able to switch rapidly between transparency and video content without sacrificing quality in bright environments.



21. Upright Storage Chillers & Freezer:

Bromic's Upright Storage Chillers and Freezers prioritise reliability through simplicity to create an affordable storage solution.

This unit's corrosion-resistant outer casing is insulated on all four sides to minimise energy consumption by allowing the refrigeration system to operate efficiently only when it is needed.



22. Fan-Forced Upright Display Chillers & Freezers:

Bromic's Fan-Forced Upright Display Chillers and Freezers are packed full of premium perks to ensure perfect performance in high-volume, self-service retail applications.

Defrosting and temperature are automatically regulated by the unit's digital controller while fast fan-forced cooling, heated glass doors and ambient ratings combine to keep products primed even in the harshest of Australian conditions.



25. Specification Reference Guide

VERTICAL DISPLAY & STORAGE

Vertical Display & Storage

Upright Display Chillers

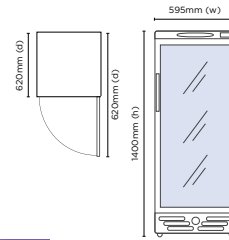

GM0220 LED ECO



Flat Glass Door 215L LED Display Chiller

Part No.	Capacity	Weight
3736033	215L	68kg

	External (mm)	Internal (mm)
Width	595	505
Depth	620	462
Height	1400	1025

- High-impact LED lighting maximises product visibility and captures attention
- Double-glazed safety glass increases efficiency while reducing condensation
- Self-closing door for hassle-free self service
- Reversible hinge for flexible installation options
- Temperature range: +1°C to +10°C

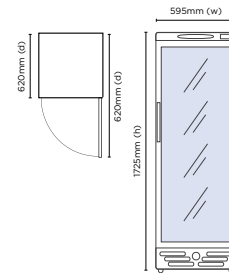

GM0300 LED ECO



Flat Glass Door 290L LED Display Chiller

Part No.	Capacity	Weight
3736034	290L	74kg

	External (mm)	Internal (mm)
Width	595	505
Depth	620	462
Height	1725	1355

- High-impact LED lighting maximises product visibility and captures attention
- Double-glazed safety glass increases efficiency while reducing condensation
- Self-closing door for hassle-free self service
- Reversible hinge for flexible installation options
- Temperature range: +1°C to +10°C

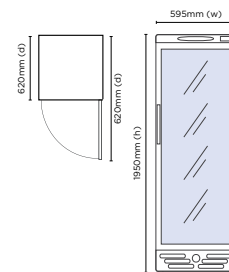

GM0374 LED ECO



Flat Glass Door 372L LED Display Chiller

Part No.	Capacity	Weight
3736035	372L	81kg

	External (mm)	Internal (mm)
Width	595	505
Depth	620	462
Height	1950	1555

- High-impact LED lighting maximises product visibility and captures attention
- Double-glazed safety glass increases efficiency while reducing condensation
- Self-closing door for hassle-free self service
- Reversible hinge for flexible installation options
- Temperature range: +1°C to +10°C

Vertical Display & Storage

Upright Display Chillers

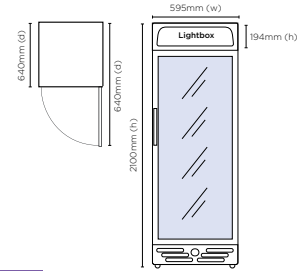

GM0374L LED ECO



Flat Glass Door 372L LED Display Chiller

Part No.	Capacity	Weight
3736036	372L	85kg
External (mm)		Internal (mm)
Width	595	505
Depth	640	462
Height	2070	1555

- High-impact LED lighting and customizable lightbox capture attention
- Double-glazed safety glass increases efficiency while reducing condensation
- Self-closing door for hassle-free self service
- Reversible hinge for flexible installation options
- Temperature range: +1°C to +10°C

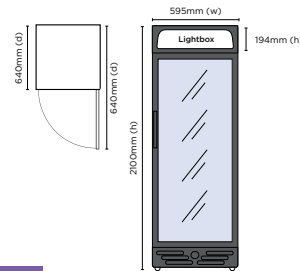

GM0374LB LED



Flat Glass Door 372L LED Display Chiller

Part No.	Capacity	Weight
3736092	372L	85kg
External (mm)		Internal (mm)
Width	595	505
Depth	640	462
Height	2070	1555

- High-impact LED lighting and customizable lightbox capture attention
- Double-glazed safety glass increases efficiency while reducing condensation
- Self-closing door for hassle-free self service
- Reversible hinge for flexible installation options
- Temperature range: +1°C to +10°C

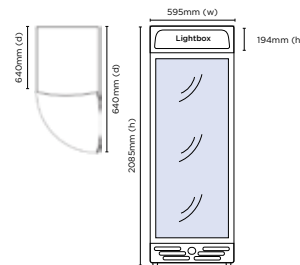

GM0400LC LED



Curved Glass Door 380L LED Display Chiller

Part No.	Capacity	Weight
3736037	380L	90kg
External (mm)		Internal (mm)
Width	595	505
Depth	640	462
Height	2085	1555

- High-impact LED lighting and customizable lightbox capture attention
- Double-glazed safety glass increases efficiency while reducing condensation
- Self-closing door for hassle-free self service
- Reversible hinge for flexible installation options
- Temperature range: +1°C to +10°C

Vertical Display & Storage

Upright Display Chillers

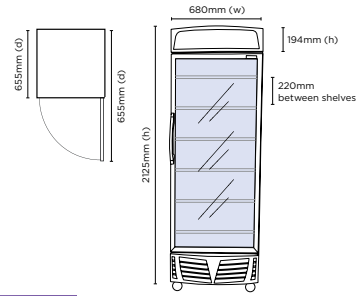

GM0440L LED



Flat Glass Door 438L LED Display Chiller

Part No.	Capacity	Weight
3736038	438L	110kg

	External (mm)	Internal (mm)
Width	680	580
Depth	655	495
Height	2125	1515

- High-impact LED lighting and customizable lightbox capture attention
- Double-glazed safety glass increases efficiency while reducing condensation
- Self-closing door for hassle-free self service
- Temperature range: +1°C to +10°C

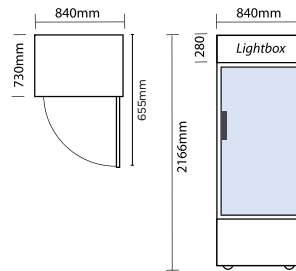

GM0660LW LED ECO



Flat Glass Door 660L LED Display Chiller

Part No.	Capacity	Weight
3736202	660L	124kg

	External (mm)	Internal (mm)
Width	840	740
Depth	730	595
Height	2166	1531

- Double-glazed safety glass door increases efficiency while heated air eliminates glass condensation
- Precise Carel digital temperature control and Embraco compressor
- Door lock to secure stock
- Doors cannot be reversed
- Illuminated light box to highlight branding
- Temperature range: +1°C to +10°C

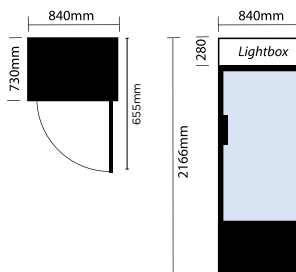

GM0660LB LED ECO



Flat Glass Door 660L LED Display Chiller

Part No.	Capacity	Weight
3736211	660L	124kg

	External (mm)	Internal (mm)
Width	840	740
Depth	730	595
Height	2166	1531

- Double-glazed safety glass door increases efficiency while heated air eliminates glass condensation
- Precise Carel digital temperature control and Embraco compressor
- Door lock to secure stock
- Doors cannot be reversed
- Illuminated light box to highlight branding
- Temperature range: +1°C to +10°C

Vertical Display & Storage

Upright Display Chillers

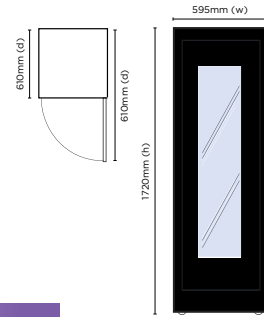

GMO300 RETRO

Retro 290L LED Display Chiller

Part No.	Capacity	Weight
3736079	290L	85kg
External (mm)		Internal (mm)
Width	595	505
Depth	610	462
Height	1720	1555

- Front glass panel with green LED surround embedded into door glass
- Completely customisable 1950s-inspired retro unit that allows endless creative freedom*
- Temperature range: +1°C to +10°C

1 YEAR
Warranty
LABOUR
& PARTS

SPECIAL
ORDER

*Minimum quantity required



Wine
Chiller

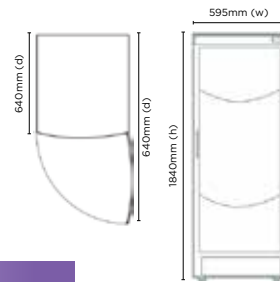

WC0400C LED ECO

Curved Glass Door 372L Wine Chiller

Part No.	Capacity	Weight
3735145	372L	84kg
External (mm)		Internal (mm)
Width	595	505
Depth	640	462
Height	1840	1555

- Reversible doors for complete flexibility
- 5 adjustable wooden shelves hold up to 50 bottles of wine
- Lockable castors make movement and placement easy
- Analogue controller with digital display for precise temperature maintenance
- Temperature range: +1°C to +18°C

1 YEAR
Warranty
LABOUR
& PARTS

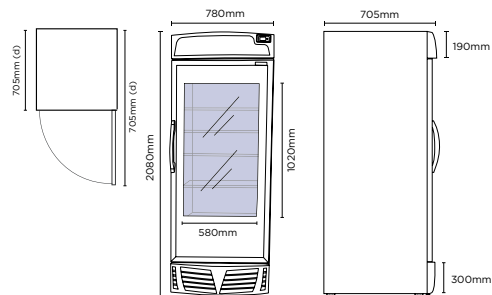

GMO690-VID

LCD Video 657L Display Chiller

Part No.	Capacity	Weight
3736090	657L	136kg
External (mm)		Internal (mm)
Width	780	555
Depth	705	702
Height	2080	1682

- 50-inch LG Ultra-High Contrast LCD display
- 1080 x 1920 screen resolution with a super wide 178° viewing angle
- Self-closing door with stay for easy stocking and hassle-free self service
- Environmentally friendly R600 refrigerant
- Temperature range: +1°C to +10°C

1 YEAR
Warranty
LABOUR
& PARTS

SPECIAL
ORDER

Vertical Display & Storage

Upright Display Chillers

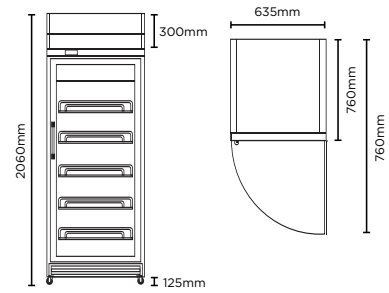

GD0500LF

Flat Glass Door 444L LED Display Chillers

Part No.	Capacity	Weight
3736245	444L	95kg

	External (mm)	Internal (mm)
Width	635	520
Depth	760	550
Height	2060	1420

- Double-glazed heated safety glass increases efficiency while reducing condensation
- Heated self-closing door with stay for easy stocking and hassle-free self service
- Temperature range: +2°C to +8°C



FF

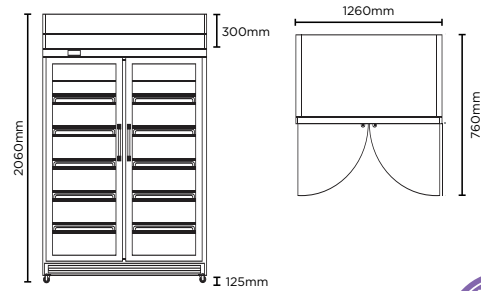

GD1000LF

Flat Glass Door 976L LED Display Chillers

Part No.	Capacity	Weight
3736246	976L	157kg

	External (mm)	Internal (mm)
Width	1260	1143
Depth	760	550
Height	2060	1420

- Double-glazed heated safety glass increases efficiency while reducing condensation
- Heated self-closing door with stay for easy stocking and hassle-free self service
- Doors cannot be reversed
- Temperature range: +2°C to +8°C



FF

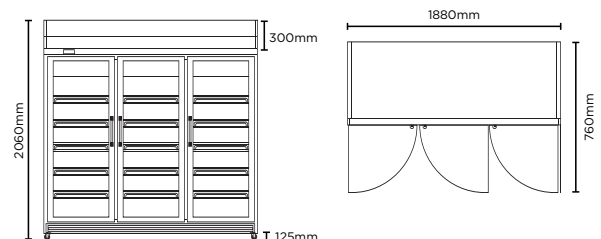

GD1500LF

Flat Glass Door 1507L LED Display Chillers

Part No.	Capacity	Weight
3736247	1507L	209kg

	External (mm)	Internal (mm)
Width	1880	1755
Depth	760	550
Height	2060	1420

- Double-glazed heated safety glass increases efficiency while reducing condensation
- Heated self-closing door with stay for easy stocking and hassle-free self service
- Doors cannot be reversed
- Temperature range: +2°C to +8°C



FF

Vertical Display & Storage

Upright Display Chillers



NEW

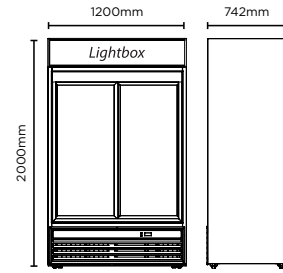

GM0980LS LED

1 YEAR
Warranty
LABOUR & PARTS

Sliding Glass Door 945L LED Display Chiller

Part No.	Capacity	Weight
3735048	945L	210kg

- High-impact LED lighting and customizable lightbox capture attention
- Double-glazed safety glass increases efficiency while reducing condensation
- Self-closing door for hassle-free self service
- Illuminated light box to highlight branding
- Temperature range: +1°C to +10°C

	External (mm)	Internal (mm)
Width	1200	1090
Depth	742	572
Height	2000	1533

FF

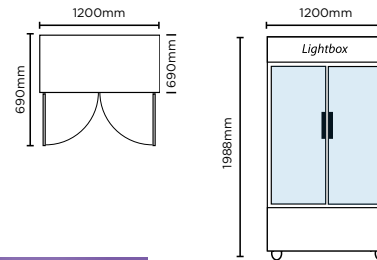

GM1000LW ECO

1 YEAR
Warranty
LABOUR & PARTS

Flat Glass Door 960L LED Eco Display Chiller

Part No.	Capacity	Weight
3736252	960L	177kg

- Ecofriendly unit operates 50% more efficiently than others, minimising power consumption maximising versatility with precise temperature control
- Mechanical controller, offers the ability to control compressor functions simply
- Illuminated light box to highlight branding
- Temperature range: +1°C to +10°C

	External (mm)	Internal (mm)
Width	1200	1090
Depth	690	545
Height	1998	1707

FF

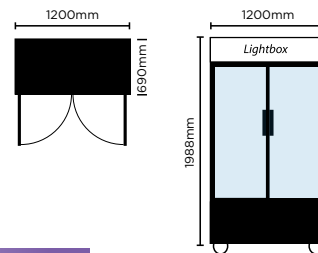

GM1000LB ECO

1 YEAR
Warranty
LABOUR & PARTS

Flat Glass Door 960L LED Eco Display Chiller

Part No.	Capacity	Weight
3736253	960L	177kg

- Ecofriendly unit operates 50% more efficiently than others, minimising power consumption maximising versatility with precise temperature control
- Mechanical controller, offers the ability to control compressor functions simply
- Illuminated light box to highlight branding
- Temperature range: +1°C to +10°C

	External (mm)	Internal (mm)
Width	1200	1090
Depth	690	545
Height	1998	1707

FF

Vertical Display & Storage

Upright Display & Storage Chillers

NEW
REMOVABLE
CASSETTE

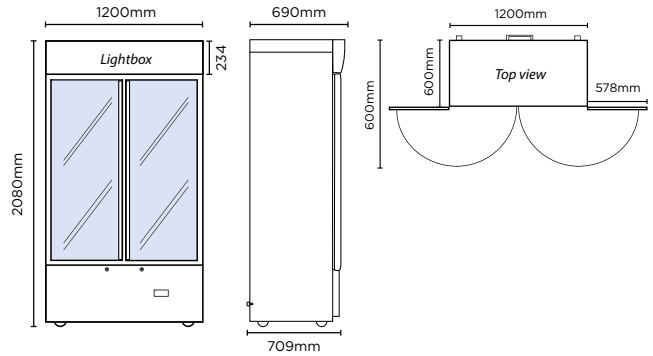

GM1000LBCAS

NEW
2 YEAR
Warranty
LABOUR
& PARTS

Cassette Flat Glass Door LED Display Chiller

Part No. 3736251 **Capacity** 960L **Weight** 188kg

	External (mm)	Internal (mm)
Width	1200	1090
Depth	690	545
Height	2080	1465

- High-impact LED internal lighting on each side for perfect product presentation
- Heated air over door prevents condensation
- Fan forced for even temperature throughout the fridge
- Adjustable stabilising floor raisers
- Removable cassette refrigeration
- Temperature range: +1°C to +5°C

FF

NEW
REMOVABLE
CASSETTE

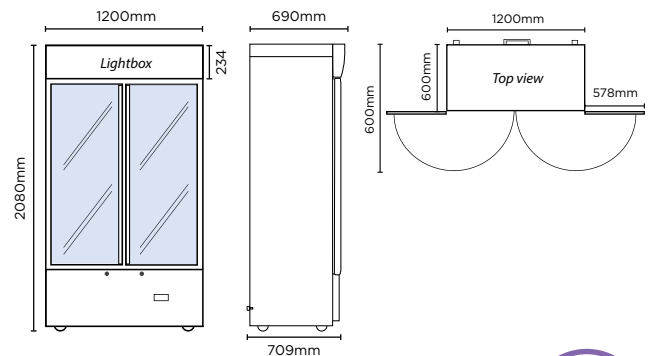

GM1000LWCAS

NEW
2 YEAR
Warranty
LABOUR
& PARTS

Cassette Flat Glass Door LED Display Chiller

Part No. 3736250 **Capacity** 960L **Weight** 188kg

	External (mm)	Internal (mm)
Width	1200	1090
Depth	690	545
Height	2080	1465

- High-impact LED internal lighting on each side for perfect product presentation
- Heated air over door prevents condensation
- Fan forced for even temperature throughout the fridge
- Adjustable stabilising floor raisers
- Aluminium door frame (white fridge only)
- Temperature range: +1°C to +5°C

FF

Vertical Display & Storage



“Whether you need to store or display your merchandise, there is an ideal Bromic solution for your needs.”

Vertical Display & Storage

Upright Storage Chillers

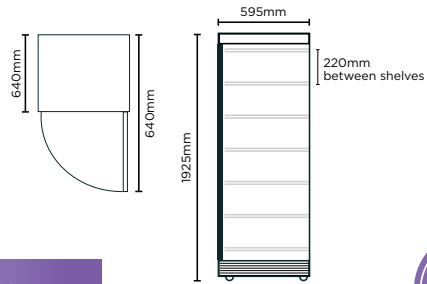

UC0374SDW

Solid Door 372L Storage Chiller

Part No.	Capacity	Weight
3735127	372L	88kg

	External (mm)	Internal (mm)
Width	595	505
Depth	640	462
Height	1925	1555

- Solid insulated coated steel door minimises heat ingress
- Reversible doors for complete flexibility
- Flexible storage with 6 adjustable shelves
- Temperature range: +1°C to +10°C

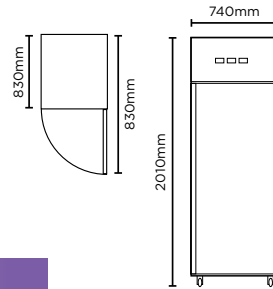

UC0650SD

Gastronome Stainless Steel 650L Storage Chiller

Part No.	Capacity	Weight
3735161	650L	143kg

	External (mm)	Internal (mm)
Width	740	624
Depth	830	685
Height	2010	1390

- Front lockable castors make movement and placement easy.
- Self-closing door provides hassle-free operation and energy efficiency. Reversible hinge for flexible installation options
- Supplied with stainless steel rails for use with 1/1 Gastronorm trays
- Dixell digital controller for precise temperature maintenance
- Temperature range: +2°C to +8°C

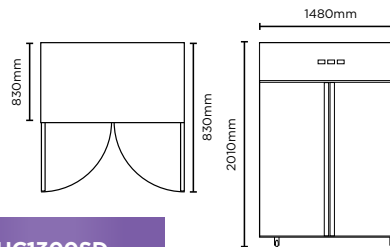

UC1300SD

Gastronorm Stainless Steel 1300L Storage Chiller

Part No.	Capacity	Weight
3735200	1300L	213kg

	External (mm)	Internal (mm)
Width	1480	1360
Depth	830	685
Height	2010	1390

- Front lockable castors make movement and placement easy
- Self-closing door provides hassle-free operation and energy efficiency
- Supplied with stainless steel rails for use with 1/1 Gastronorm trays
- Dixell digital controller for precise temperature maintenance
- Temperature range: +2°C to +8°C



Vertical Display & Storage

Upright Display Freezers

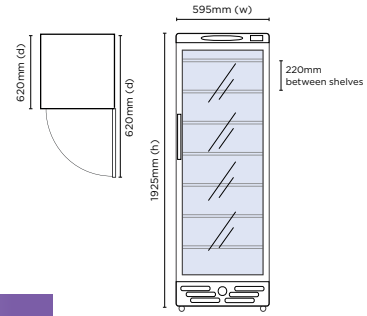

UF0374S LED



Flat Glass Door 300L LED Display Freezer

Part No.	Capacity	Weight
3736045	300L	102kg
	External (mm)	Internal (mm)
Width	595	475
Depth	620	440
Height	1925	1550

- High-impact LED lighting maximises product visibility and captures attention
- Self-closing door for hassle-free self service
- Reversible hinge for flexible installation options
- Refrigeration integrated into all 6 fixed shelves for even cooling
- Temperature range: -19°C to -14°C

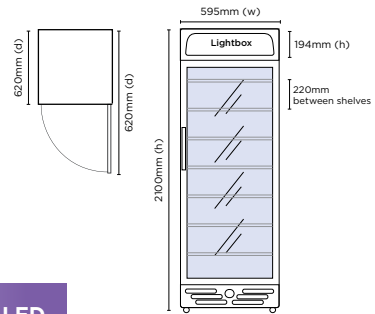

UF0374LS LED



Flat Glass Door 300L LED Display Freezer

Part No.	Capacity	Weight
3736046	300L	106kg
	External (mm)	Internal (mm)
Width	595	475
Depth	620	440
Height	2100	1550

- High-impact LED lighting and customizable lightbox capture attention
- Self-closing door for hassle-free self service
- Reversible hinge for flexible installation options
- Refrigeration integrated into all 6 fixed shelves for even cooling
- Temperature range: -19°C to -14°C

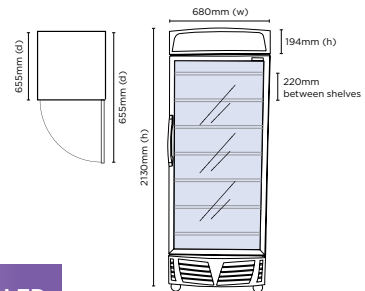

UF0440LS LED



Flat Glass Door 440L LED Display Freezer

Part No.	Capacity	Weight
3736047	440L	123kg
	External (mm)	Internal (mm)
Width	680	577
Depth	655	495
Height	2133	1510

- High-impact LED lighting and customizable lightbox capture attention
- Self-closing door for hassle-free self service
- Reversible hinge for flexible installation options
- Refrigeration integrated into all 6 fixed shelves for even cooling
- Temperature range: -19°C to -14°C

Vertical Display & Storage

Upright Display Freezers

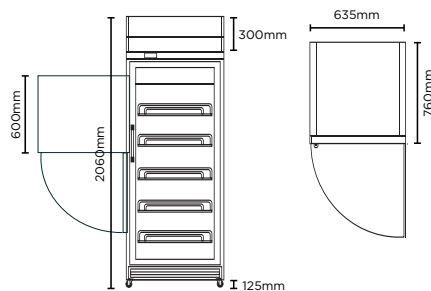

UF0500LF



Flat Glass Door 444L LED Display Freezer

Part No. 3736240 **Capacity** 444L **Weight** 113kg

	External (mm)	Internal (mm)
Width	635	520
Depth	760	550
Height	2060	1420

- Fan-forced refrigeration system
- Triple-glazed heated safety glass increases efficiency while reducing condensation
- Heated self-closing door with stay for easy stocking and hassle-free self service
- Temperature range: -22°C to -18°C

FF

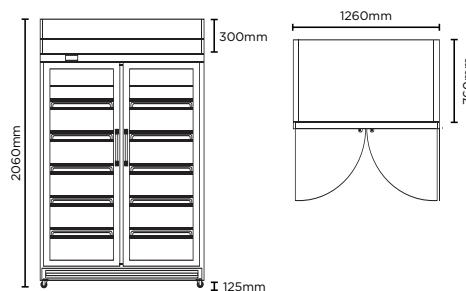

UF1000LF



Flat Glass Door 976L LED Display Freezer

Part No. 3736241 **Capacity** 976L **Weight** 199kg

	External (mm)	Internal (mm)
Width	1260	1143
Depth	760	550
Height	2060	1420

- Fan-forced refrigeration system
- Triple-glazed heated safety glass increases efficiency while reducing condensation
- Heated self-closing door with stay for easy stocking and hassle-free self service
- Temperature range: -22°C to -18°C

FF

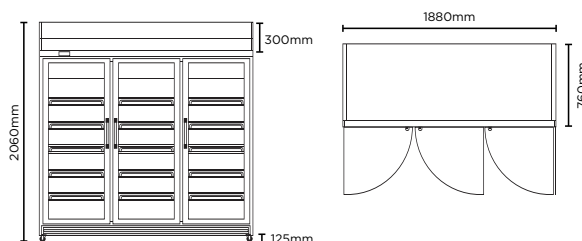

UF1500LF



Flat Glass Door 1507L LED Display Freezer

Part No. 3736242 **Capacity** 1507L **Weight** 279kg

	External (mm)	Internal (mm)
Width	1880	1755
Depth	760	550
Height	2060	1420

- Fan-forced refrigeration system
- Triple-glazed heated safety glass increases efficiency while reducing condensation
- Heated self-closing door with stay for easy stocking and hassle-free self service
- Temperature range: -22°C to -18°C

Vertical Display & Storage 23

Vertical Display & Storage

Upright Storage Freezers

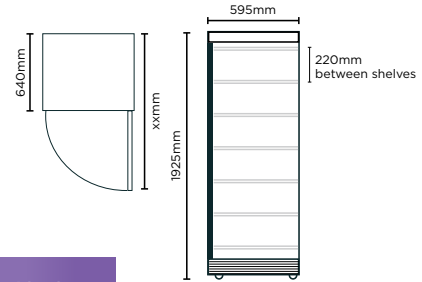

UF0374SDS

1 YEAR
Warranty
LABOUR
& PARTS

Solid Door 300L Freezer

Part No.	Capacity	Weight
3735106	300L	79.5kg
External (mm)		Internal (mm)
Width	595	475
Depth	600	440
Height	1925	1550

- Lockable castors make movement and placement easy
- Solid insulated steel door minimises heat ingress
- Refrigeration integrated into all 6 fixed shelves for even cooling
- Temperature range: -19°C to -14°C

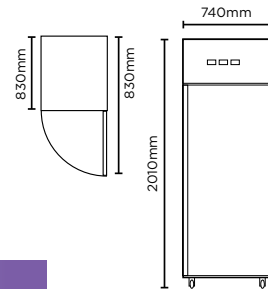

UF0650SDF

NEW
2 YEAR
Warranty
LABOUR
& PARTS

Gastronorm Stainless Steel 650L Storage Freezer

Part No.	Capacity	Weight
3735203	650L	147kg
External (mm)		Internal (mm)
Width	740	624
Depth	830	685
Height	2010	1390

- Lockable castors make movement and placement easy
- Self-closing door provides hassle-free operation and energy efficiency
- Supplied with stainless steel rails for use with 1/1 Gastronorm trays
- Dixell digital controller for precise temperature maintenance
- Temperature range: -22°C to -18°C

FF

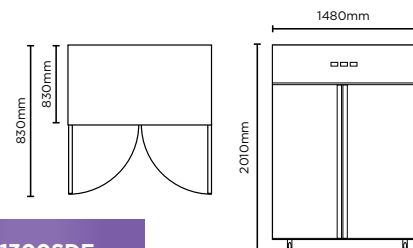

UF1300SDF

NEW
2 YEAR
Warranty
LABOUR
& PARTS

Gastronorm Stainless Steel 1300L Storage Freezer

Part No.	Capacity	Weight
3735194	1300L	226kg
External (mm)		Internal (mm)
Width	1480	1360
Depth	830	685
Height	2010	1390

- Lockable castors make movement and placement easy
- Self-closing door provides hassle-free operation and energy efficiency
- Supplied with stainless steel rails for use with 1/1 Gastronorm trays
- Dixell digital controller for precise temperature maintenance
- Temperature range: -22°C to -18°C

FF

Vertical Display & Storage

Specification Reference Guide

Chiller

Freezer

Model	GM0220 LED	GM0300 LED	GM0374 LED	GM0374L LED	GM0374LB LED
Part Number	3736033	3736034	3736035	3736036	3736092
Ext. Width (mm)*	595	595	595	595	595
Ext. Depth (mm)*	620	620	620	640	640
Ext. Height (mm)*	1400	1725	1950	2070	2070
Capacity	215L	290L	372L	372L	372L
Temp. Range	+1 to +10°C	+1 to +10°C	+1 to +10°C	+1 to +10°C	+1 to +10°C
Max. Ambient Temp.	40°C	40°C	40°C	40°C	40°C
Refrigeration Power	235W	290W	350W	370W	370W
Current	2.0A	2.0A	2.6A	2.7A	2.7A
Gross Weight	68kg	74kg	81kg	85kg	85kg
Refrigerant	R134a	R134a	R134a	R134a	R134a
Plug Supplied	1	1	1	1	1
Power Supply	10A	10A	10A	10A	10A
Features					
Chiller Case	✓	✓	✓	✓	✓
Freezer Case					
Display Light Box				✓	✓
Main Light	LED	LED	LED	LED	LED
Door Shape	Flat	Flat	Flat	Flat	Flat
Safety Glass	✓	✓	✓	✓	✓
Door Lock					
No. of Doors	1	1	1	1	1
Self-Closing Door	✓	✓	✓	✓	✓
Temp. Controller	Analogue	Analogue	Analogue	Analogue	Analogue
Castors	✓	✓	✓	✓	✓
No. of Shelves Incl. Base Per Door	4	5	6	6	6
Colour	Silver	Silver	Silver	Silver	Black/White
Warranty					
Parts (Years)	1	1	1	1	1
Labour (Years)	1	1	1	1	1

*Depth dimensions exclude lightbox & handle protrusions

Vertical Display & Storage

Specification Reference Guide

Chiller

Freezer

Model	GM0400LC LED	GM0440L LED	GM0660LW LED	GM0660LB LED	GM1000LBCAS	GM1000LWCAS
Part Number	3736037	3736038	3736202	3736211	3736251	3736250
Ext. Width (mm)*	595	680	840	840	1200	1200
Ext. Depth (mm)*	640	655	730	730	690	690
Ext. Height (mm)*	2085	2125	2166	2166	2080	2080
Capacity	380L	438L	660L	660L	960L	960L
Temp. Range	+1 to +10°C	+1 to +10°C	+1 to +10°C	+1 to +10°C	+1 to +5°C	+1 to +5°C
Max. Ambient Temp.	40°C	40°C	40°C	40°C	38°C	38°C
Refrigeration Power	370W	390W	460W	460W	520W	520W
Current	2.7A	3.3A	3.3A	3.3A	2.3A	2.3A
Gross Weight	90kg	110kg	124kg	124kg	188kg	188kg
Refrigerant	R134a	R134a	R134a	R134a	R290a	R290a
Plug Supplied	1	1	1	1	1	1
Power Supply	10A	10A	10A	10A	10A	10A
Features						
Chiller Case	✓	✓	✓	✓	✓	✓
Freezer Case						
Display Light Box	✓	✓	✓	✓	✓	✓
Main Light	LED	LED	LED	LED	LED	LED
Door Shape	Curved	Flat	Flat	Flat	Flat	Flat
Safety Glass	✓	✓	✓	✓	✓	✓
Door Lock			✓	✓	✓	✓
No. of Doors	1	1	1	1	2	2
Self-Closing Door	✓	✓	✓	✓	✓	✓
Temp. Controller	Analogue	Analogue	Digital	Digital	Digital	Digital
Castors	✓	✓	✓	✓	✓	✓
No. of Shelves Incl. Base Per Door	6	6	6	6	6	6
Colour	Silver	Silver	White	Black	Black	White
Warranty						
Parts (Years)	1	1	1	1	2	2
Labour (Years)	1	1	1	1	2	2

*Depth dimensions exclude lightbox & handle protrusions

Vertical Display & Storage

Specification Reference Guide

Chiller

Freezer

Model	SPECIAL ORDER		SPECIAL ORDER			
	GM0300 RETRO	WC0400C LED	GM0690-VID	GD0500LF	GD1000LF	GD1500LF
Part Number	3736079	3735145	3736090	3736245	3736246	3736247
Ext. Width (mm)*	595	595	780	635	1260	1880
Ext. Depth (mm)*	610	610	705	760	760	760
Ext. Height (mm)*	1720	1840	2080	2060	2060	2060
Capacity	290L	372L	657L	444L	976L	1507L
Temp. Range	+1 to +10°C	+1 to +18°C	+1 to +10°C	+2 to +8°C	+2 to +8°C	+2 to +8°C
Max. Ambient Temp.	40°C	40°C	32°C	38°C	38°C	38°C
Refrigeration Power	290W	270W	485W	740W	1000W	1132W
Current	2.0A	1.8A	3.8A	4.5A	5.6A	7.0A
Gross Weight	85kg	84kg	136kg	95kg	157kg	209kg
Refrigerant	R134a	R134a	R134a	R134a	R134a	R134a
Plug Supplied	1	1	1	1	1	1
Power Supply	10A	10A	10A	10A	10A	10A
Features						
Chiller Case	✓	✓	✓	✓	✓	✓
Freezer Case						
Display Light Box			✓	✓	✓	✓
Main Light	LED	LED	LED	LED	LED	LED
Door Shape	Flat	Curved	TV	Flat	Flat	Flat
Safety Glass	✓	✓	✓	✓	✓	✓
Door Lock				✓	✓	✓
No. of Doors	1	1	1	1	2	3
Self-Closing Door	✓	✓	✓	✓	✓	✓
Temp. Controller	Analogue	Analogue	Digital	Digital	Digital	Digital
Castors	✓	✓	✓	✓	✓	✓
No. of Shelves Incl. Base Per Door	5	6	5	6	6	6
Colour	Black/Custom	Silver	Silver	White with S/Steel Trim	White with S/Steel Trim	White with S/Steel Trim
Warranty						
Parts (Years)	1	1	1	1	1	1
Labour (Years)	1	1	1	1	1	1

*Depth dimensions exclude lightbox & handle protrusions

Vertical Display & Storage

Specification Reference Guide

Chiller

Freezer





Model	GM0980LS LED	GM1000LW ECO	GM1000LB ECO	UC0374SDW	UC0650SD	UC1300SD
Part Number	3735048	3736252	3736253	3735127	3735161	3735200
Ext. Width (mm)*	1200	1200	1200	595	740	1480
Ext. Depth (mm)*	742	690	690	640	830	830
Ext. Height (mm)*	2000	1998	1998	1925	2010	2133
Capacity	945L	960L	960L	372L	650L	1300L
Temp. Range	+1 to +10°C	+1 to +10°C	+1 to +10°C	+1 to +10°C	+2 to +8°C	+2 to +8°C
Max. Ambient Temp.	40°C	38°C	38°C	40°C	38°C	38°C
Refrigeration Power	850W	650W	650W	350W	360W	520W
Current	5.8A	4A	4A	2.6A	2.2A	4.2A
Gross Weight	210kg	177kg	177kg	88kg	143kg	213kg
Refrigerant	R134a	R290	R290	R134a	R134a	R134a
Plug Supplied	1	1	1	1	1	1
Power Supply	10A	10A	10A	10A	10A	10A
Features						
Chiller Case	✓	✓	✓	✓	✓	✓
Freezer Case						
Display Light Box	✓	✓	✓			
Main Light	LED	LED	LED	Fluorescent	LED	LED
Door Shape	Flat	Flat	Flat	Flat	Flat	Flat
Safety Glass	✓	✓	✓			
Door Lock		✓	✓		✓	✓
No. of Doors	2	2	2	1	1	2
Self-Closing Door	✓	✓	✓	✓	✓	✓
Temp. Controller	Digital	Analogue	Analogue	Analogue	Digital	Digital
Castors		✓	✓	✓	✓	✓
No. of Shelves Incl. Base Per Door	5	5	5	7	6	6
Colour	Black	White	Black	Black/White	Stainless Steel	Stainless Steel
Warranty						
Parts (Years)	1	1	1	1	2	2
Labour (Years)	1	1	1	1	2	2

Vertical Display & Storage

Specification Reference Guide

Chiller

Freezer

Model	UF0374S LED 	UF0374LS LED 	UF0440LS LED 	UF0500LF 	UF1000LF 
Part Number	3736045	3736046	3736047	3736240	3736241
Ext. Width (mm)*	595	595	680	635	1260
Ext. Depth (mm)*	620	620	655	760	760
Ext. Height (mm)*	1925	2100	2130	2060	2060
Capacity	300L	300L	440L	444L	976L
Temp. Range	-19 to -14°C	-19 to -14°C	-19 to -14°C	-22 to -18°C	-22 to -18°C
Max. Ambient Temp.	35°C	35°C	35°C	38°C	38°C
Refrigeration Power	620W	635W	867W	1000W	1600W
Current	3.9A	4.1A	5.6A	4.7A	8A
Gross Weight	102kg	106kg	123kg	113kg	199kg
Refrigerant	R404a	R404a	R404a	R404a	R404a
Plug Supplied	1	1	1	1	1
Power Supply	10A	10A	10A	10A	10A
Features					
Chiller Case					
Freezer Case	✓	✓	✓	✓	✓
Display Light Box		✓	✓	✓	✓
Main Light	LED	LED	LED	LED	LED
Door Shape	Flat	Flat	Flat	Flat	Flat
Safety Glass	✓	✓	✓	✓	✓
Door Lock				✓	✓
No. of Doors	1	1	1	1	2
Self-Closing Door	✓	✓	✓	✓	✓
Temp. Controller	Analogue	Analogue	Analogue	Digital	Digital
Castors	✓	✓	✓	✓	✓
No. of Shelves Incl. Base Per Door	7	7	7	6	6
Colour	Silver	Silver	Silver	White with S/Steel Trim	White with S/Steel Trim
Warranty					
Parts (Years)	1	1	1	1	1
Labour (Years)	1	1	1	1	1

Vertical Display & Storage

Specification Reference Guide

Chiller

Freezer

Model	UF1500LF	UF0374SDS	UF0650SDF	UF1300SDF
Part Number	3736242	3735106	3735203	3735194
Ext. Width (mm)*	1880	595	740	1480
Ext. Depth (mm)*	760	600	830	830
Ext. Height (mm)*	2060	1925	2010	2010
Capacity	1507L	300L	650L	1300L
Temp. Range	-22 to -18°C	-19 to -14°C	-22 to -18°C	-22 to -18°C
Max. Ambient Temp.	38°C	35°C	38°C	38°C
Refrigeration Power	2000W	270W	640W	800W
Current	9A	2.4A	2.8A	4.8A
Gross Weight	279kg	79.5kg	147kg	226kg
Refrigerant	R404a	R404a	R404a	R404a
Plug Supplied	1	1	1	1
Power Supply	15A	10A	10A	10A
Features				
Chiller Case				
Freezer Case	✓	✓	✓	✓
Display Light Box	✓			
Main Light	LED	Fluorescent	LED	LED
Door Shape	Flat	Flat	Flat	Flat
Safety Glass	✓			
Door Lock	✓		✓	✓
No. of Doors	3	1	1	2
Self-Closing Door	✓	✓	✓	✓
Temp. Controller	Digital	Analogue	Digital	Digital
Castors	✓	✓	✓	✓
No. of Shelves Incl. Base Per Door	6	7	6	6
Colour	White with S/Steel Trim	Black/White	Stainless Steel	Stainless Steel
Warranty				
Parts (Years)	1	1	2	2
Labour (Years)	1	1	2	2