

GIORIK
INNOVATIVE COOKING EQUIPMENT SINCE 1963

**Steam
BOX**
EVOLUTION

ESSENCE OF EVOLUTION COMBI OVENS



 **STODDART®**



HIGH-EFFICIENCY BOILER

Highly efficient, low water use boiler is unique to STEAMBOX EVOLUTION, providing outstanding performance levels - reducing time, water use and energy consumption



SYMBIOTIC SYSTEM

STEAMBOX EVOLUTION's patented systems combine Boiler Integration with the optimum aspects of its High Efficiency Steam Generator to provide unique, precise and continuous moisture control



METEO SYSTEM

Precise humidity control is fitted to STEAMBOX EVOLUTION oven to constantly monitor the required percentage of steam, ensuring tender, succulent and appetising cooking results while minimising weight loss



STEAM TUNER

STEAMBOX EVOLUTION achieves optimum results by controlling the Quantity and Quality of steam saturation and penetration with Patented Steam Tuner



TOUCH

STEAMBOX EVOLUTION's Large 9" Touch Screen display allows for an Intuitive user interface for precise control



INTUITIVE PROGRAMMING

Personalise STEAMBOX EVOLUTION with multiple cooking times or core temperatures simultaneously with preloaded programmable recipes



GIORIK



RACK CONTROL

The Easy Service option enables different dishes to be cooked at the same time at various levels



ROOSTER BOOSTER

Giorik patented micro-boiler built into STEAMBOX EVOLUTION, limits consumption to 1kW, delivering cooked chickens in just 30 minutes



AUTOMATIC WASH SYSTEM

STEAMBOX EVOLUTION's Automatic wash system offers a choice of 4 wash levels as standard and a closed circuit with minimal water usage



CLEANING WITH TABLETS

The new closed circuit system allows the user to use solid detergent (tablets)



ACCESSORIES

Large range of accessories to meet all innovative cooking needs

The Range









6 x 1/1GN



10 x 1/1GN



20 x 1/1GN

| Model | Dimension (WxDxH) | Capacity | Voltage | Power | Gas |
|---|-------------------|------------|-----------------|-------|------|
|  SEHE061WT | 863 x 855 x 881 | 6 x 1/1GN | 415V 3Ø + N + E | 12.4 | - |
|  SEHG061WT | 863 x 855 x 881 | 6 x 1/1GN | 230V 1Ø + N + E | 1.4 | 43.2 |
|  SEHE101WT | 863 x 855 x 1161 | 10 x 1/1GN | 415V 3Ø + N + E | 18.2 | - |
|  SEHG101WT | 863 x 855 x 1161 | 10 x 1/1GN | 230V 1Ø + N + E | 1.5 | 68.4 |
|  SEHE201WT | 998 x 925 x 1888 | 20 x 1/1GN | 415V 3Ø + N + E | 36.7 | - |
|  SEHG201WT | 998 x 925 x 1888 | 20 x 1/1GN | 230V 1Ø + N + E | 3.3 | 68.4 |

*MJ rating subject to Gas Certification, please refer to current data sheet

STEAMBOX EVOLUTION innovative range from Giorik, sets the new norm for Combi Ovens where technological research and development defines new benchmarks.

STEAMBOX EVOLUTION range has evolved to meet these new benchmarks.



6 x 2/1GN

10 x 2/1GN

20 x 2/1GN

| Model | Dimension (WxDxH) | Capacity | Voltage | Power | Gas |
|---|-------------------|------------|-------------------|-------|-------|
|  SEHE062WT | mm | GN | V (50Hz opz.60Hz) | kW | *MJ |
|  SEHE062WT | 1123 x 925 x 879 | 6 x 2/1GN | 415V 3Ø + N + E | 23.1 | - |
|  SEHG062WT | 1123 x 925 x 879 | 6 x 2/1GN | 230V 1Ø + N + E | 1.4 | 72 |
|  SEHE102WT | 1123 x 925 x 1159 | 10 x 2/1GN | 415V 3Ø + N + E | 28.3 | - |
|  SEHG102WT | 1123 x 925 x 1159 | 10 x 2/1GN | 230V 1Ø + N + E | 3.3 | 100.8 |
|  SEHE202WT | 1198 x 985 x 1885 | 20 x 2/1GN | 415V 3Ø + N + E | 54.1 | - |
|  SEHG202WT | 1198 x 985 x 1885 | 20 x 2/1GN | 230V 1Ø + N + E | 4.1 | 100.8 |

*MJ rating subject to Gas Certification, please refer to current data sheet



- (1) **Door** - Innovative cooling system that prevents risk of burns, oven and door are designed with double steam collector
- (2) **Lighting** - LED lighting is fitted to the door to provide excellent illumination inside the cooking chamber
- (3) **Navigation Control** - Recessed into control panel to reduce the risk of breakage

- (4) **Touch Screen** - Large 9" touch screen
- (5) **Steam Tuner** - Fitted with a patented system to control QUANTITY and QUALITY of Steam in the cooking chamber
- (6) **Instrument Compartment** - Fully ventilated and protected by a dust filter. Easily accessible from the front of the oven (no need to move oven)

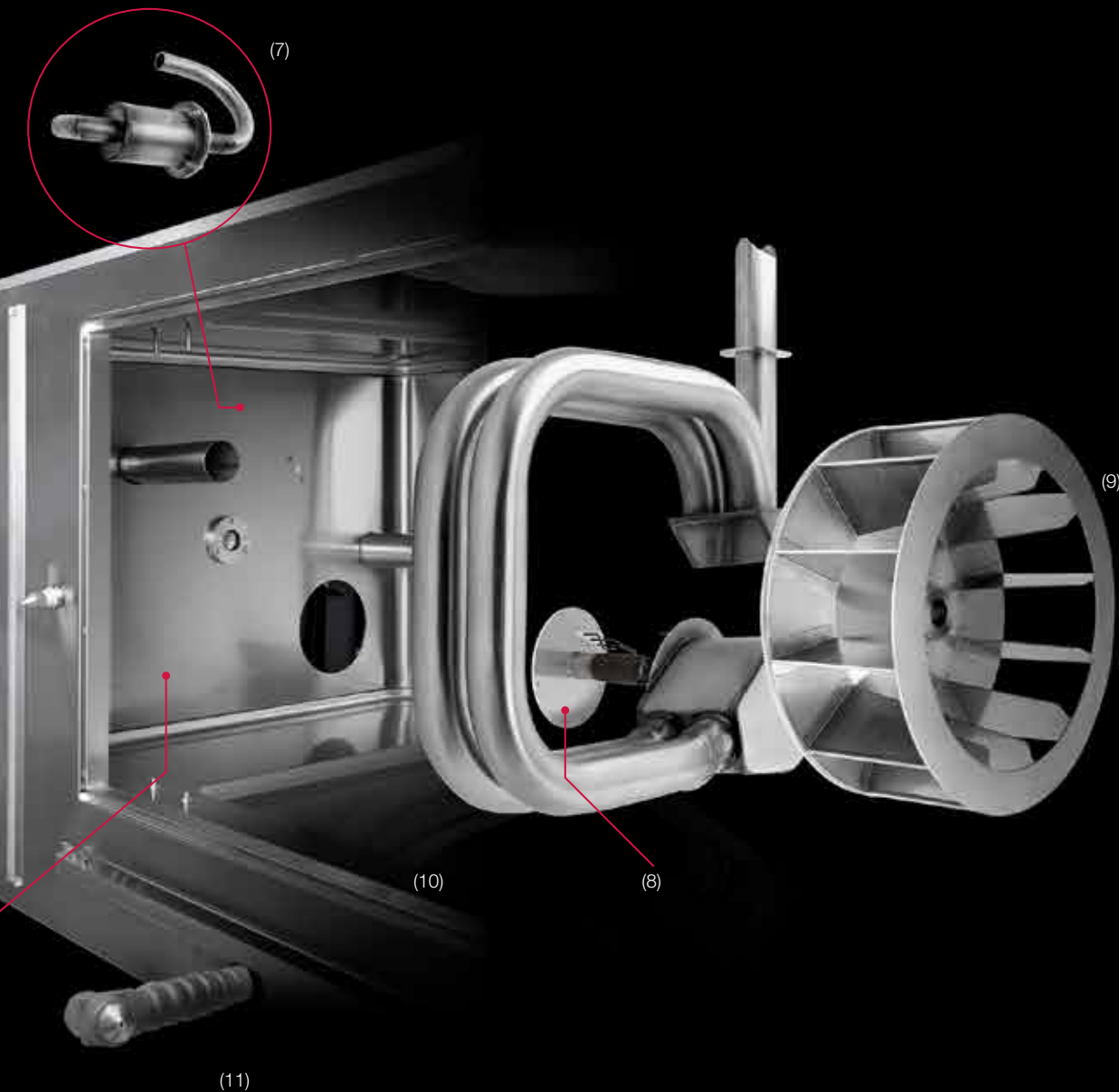

(7) Humidity Control - *Meteo System, a unique patented system designed to constantly monitor the climatic conditions inside the cooking chamber*

(8) Premix Burner System - *Gas ovens have special burners fitted providing optimum combustion and heat yield*

(9) Convection Fan - *6-speed fan with electronic inverter making it possible to set fan inversion time to zero*

(10) Cooking Chamber - *Designed with **NO** seams to avoid build-up of dirt and grime. Easy to remove pan racks and deflector for cleaning*

(11) Hand Spray - *Retractable hand spray nozzle makes it easy to clean the cooking chamber*

(12) High-Efficiency Boiler - *Highly efficient, low water use boiler, provides outstanding performance levels - reducing time, water use and energy consumption*

Low running costs

Giorik's STEAMBOX EVOLUTION oven range has a patented steam generation system that makes it possible to ensure the size of the boiler is much smaller than those in traditional Combi ovens. This unique feature, combined with the outstanding characteristics of the High-Efficiency system, makes it possible to dramatically reduce water and energy consumption, but also reducing cooking times.

STEAMBOX EVOLUTION's micro generator keeps energy consumption down to previously unseen or capable minimums. This assures substantial energy and water savings from both an economic and an environmental point of view.

The advantages of this system are easy to measure –





Symbiotic System, steam generation patented by Giorik

Boiler + Instant = A Winning Combination

Steambox has two methods of generating steam side by side:

- Boiler Generated
- Instant mode

Working in synergy these two methods make it possible to gain maximum benefits from both individual systems, by programming STEAMBOX EVOLUTION for the best application of either process or both.

Unbeatable Speed

With the ability to use either or both of the two methods (Instant + Boiler), STEAMBOX EVOLUTION produces steam in a shorter time than that required by traditional Combi systems. This symbiotic system stabilises the steam, by ramping up the Boiler to speed up production when instant production decreases due to the cooling of the heating elements.

High-Quality Steam At All Times

STEAMBOX EVOLUTION's symbiotic system ensures constant saturation of the cooking chamber and guarantees precise and continuous moisture control. Steam quality can be unpredictable and as a result optimum outcomes cannot be guaranteed. When steam is too dry, or temperatures are too high, food tends to oxidise or burn. Alternatively, when there is too much moisture in the steam, food can be "drenched". Achieve unmatched results every time with STEAMBOX EVOLUTION.

Gas version available

STEAMBOX EVOLUTION is available in gas models and six sizes, 6 x 1/1GN, 10 x 1/1GN, 20 x 1/1GN and 6 x 2/1GN, 10 x 2/1GN and 20 x 2/1GN. STEAMBOX EVOLUTION's gas models have specialised burners designed to premix gas and air while the high-efficiency heat exchanger guarantees optimum combustion and heat yield.

Smart Steam



The humidity control system fitted to STEAMBOX EVOLUTION ovens make it possible to constantly monitor the climatic conditions inside the cooking chamber and adjust, as required, to maintain the proper degree of humidity. Proprietary software analyses reference parameters in the cooking chamber and modulates the steam environment to ensure ideal conditions for every style of cooking.

Excess Humidity

To extract excess humidity quickly and completely, a servo-controlled butterfly valve releases pressurized air from the oven cavity.

With a specially designed drain trap assembled within the oven cavity, cooking times are accelerated and heat loss is minimised.

Correct Water Consumption

The unique Meteo humidity control system allows for precise water consumption and minimal waste, due to steam production being optimised according to real cooking needs. Water required to reduce steam condensation is then used in a more economical way, reducing consumption even further.

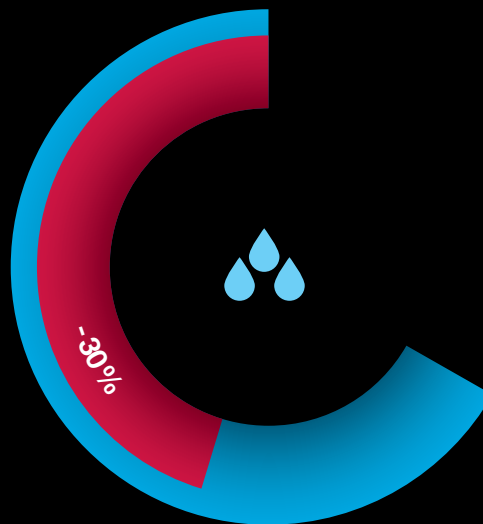

Reduced Water Consumption
when using steam

■ STEAMBOX
■ Traditional system

Quality Steam Tuning

steam tuner

STEAMBOX EVOLUTION ovens allow the user to determine both the QUANTITY and the QUALITY of the steam in the cooking chamber. The patented Steam Tuner system allows the user to adjust the degree of steam hydration to the precise level of dryness or humidity depending on the type of cooking desired.

Although considered to be of superior quality, “dry” steam is not always suited to some food to obtain the desired result. When cooking large food items or food with particularly dense fibres, it is advisable to use steam with the proper degree of hydration and penetration, which will cook the food faster while preserving the tenderness. Only Steam Tuner can deliver options of steam.



Steambox Touch



STEAMBOX features a large 9" touch screen display. Experience a faster and more intuitive user interface.

TOUCH SCREEN VERSION

1 On/Off

2 Touch-screen panel:

- Cooking modes: convection, mixed, steam, cooling, holding, smoking
- Timed, probe or Delta-T cooking
- 5-level SteamTuner
- Cooking method programs (grill, roast, braise, au gratin, fry, smoke, bread and pastry cooking, steam cooking)
- Recipe Tuner
- Overnight cooking
- RackControl with EasyService
- Regeneration
- Automatic cleaning with boiler cleaning (standard)

3 Navigation Control to navigate the oven functions. Push-to-set function to quick set all the cooking parameters

GIORIK

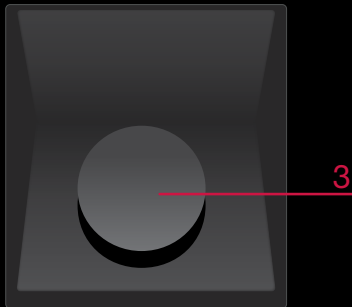

GIORIK ON-AIR



All Giorik ovens are fitted with a device which can connect them to the Giorik / Stoddart Cloud. This allows information about the oven to be gathered, so equipment errors and parameters can be analysed remotely. Connection to the Cloud also enables the ovens software to be updated in real time.

Intuitive Programming

RecipeTuner

The STEAMBOX EVOLUTION range incorporates an innovative RecipeTuner interface which creates the possibility to modify and personalise the various programs simply and intuitively.

RecipeTuner changes according to the type of cooking set, to regulate cooking, browning, degree of humidity and of leavening. The interfaces works with both pre-set programs and those created by the chef.



EasyService level control cooking

The new Rack Control enables different dishes to be cooked at the same time at various levels. With EasyService, the new Rack Control function, all the dishes can be served at the same time.

Rooster Booster

STEAMBOX EVOLUTION has developed the Rooster Booster, designed for specifically cooking chickens. Harnessing the power and speed of the unique patented Steam Generation system, guarantees shorter cook times, minimal loss in weight and a perfectly cooked product.

The Giorik patented micro-boiler, limits consumption to 1 kW, delivering cooked chickens in just 30 minutes.



*Indent item only - Contact your local Stoddart representative for more information.



PASS THROUGH VERSION

STEAMBOX EVOLUTION Rooster Booster can be supplied in a PASS-THROUGH version, with a rear door instead of the rear fixed panel. In a Retail environment this is useful with product being prepared and loaded in a production area and retail staff in front of house having the ability to unload directly to the retail space.

FAT SEPARATOR

STEAMBOX EVOLUTION Rooster Booster is supplied with a fat collection tray. Fats will be channelled into a collector beneath the cooking chamber. This reduces evaporation or burning during cooking. After use, the tray can be removed, together with the grid, drained and placed in the dishwasher for cleaning.

The oven can then be cleaned using one of the automatic self-washing cycles and fats gathered in the tank beneath the oven flushed to grease pits.



Top of the range Wash System

All STEAMBOX EVOLUTION models are supplied with an AUTOMATIC WASH SYSTEM. This intuitive interface allows users to simultaneously start cleaning at the end of the cooking cycle or end of the day by selecting one of the four wash programmes available, from HARD to rinsing only. The cooking chamber has been specially designed with an exclusive CLOSED CIRCUIT wash system. This offers multiple benefits:



- STEAMBOX EVOLUTION's new CLOSED CIRCUIT system uses the minimum amount of water necessary, with obvious economic and environmental benefits
- Both liquid and solid (tabs) detergent can be used with the new CLOSED CIRCUIT system

STEAMBOX EVOLUTION automatically cleans the boiler on a regular basis, depending on how much the boiler has been used, alleviating the need for the operator to perform this manually.

The boiler is cleaned with an organic rinse aid or with white vinegar.



Solid detergent (tablets)



Liquid detergent

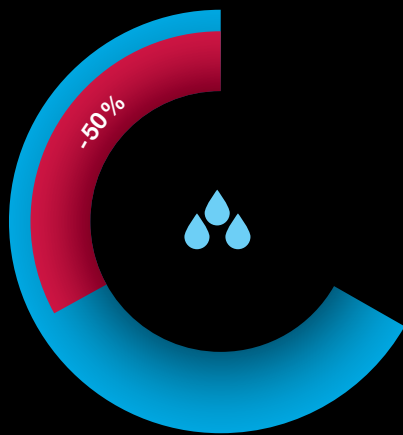

Reduced Water Consumption

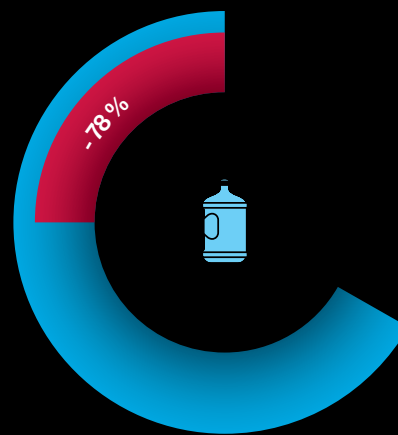
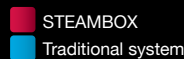

Reduced Cleaning Consumption

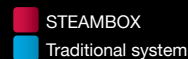

GREEN RINSING SYSTEM

Innovative eco-friendly, organic rinse-aid available.

ECO-FRIENDLY

Automatic closed-cycle system guarantees maximum hygiene in the cooking chamber with minimum water consumption.

RECOMMENDED PRODUCTS

In order to avoid damage to the cooking chamber surfaces we recommend a series of non-abrasive de-greasing products which have been developed. Like all the other features of the oven, the cleaning function has been optimised to reduce energy and product consumption.

SELF-CLEANING BOILER

At particular intervals, depending on the amount the boiler is used, STEAMBOX EVOLUTION automatically cleans the boiler, with no need for the operator to do this manually. The boiler is cleaned with the organic rinse-aid or with white vinegar.

CLEANING OPTIONS

Either liquid detergent or special sanitising tablets can be used. Rinsing can be performed with an organic rinse-aid or white vinegar. The system functions completely independently with no requirement for an operator. Cleaning can be done overnight, presenting a clean oven the following morning.



The right tray for all cooking needs

STEAMBOX ovens have a wide range of trays and pans specially designed to meet all cooking needs. They are strong and sturdy and guarantee perfect distribution of heat, making Giorik trays a must-have for any professional kitchen.



In the photo above:

- Cannelloni: stainless steel tray 20 mm (h)
- Skewers: skewer kit (ring + skewers)
- Poached eggs: tray for fried eggs
- Chops: non-stick aluminium grill
- Chickens: tray for grilled chickens (birds, spring chickens, duck)
- Steamed vegetables: perforated inox tray 40 mm (h)
- Croissants: non-stick micro perforated aluminium tray



**mini
touch**

A revolutionary compact mini oven with intuitive & innovative touch-screen controls.

KORE

The only compact oven with a boiler, maximising efficiency in the smallest space.

Essence Of Evolution



MOVAIR

MovAir is one of a kind, complete with innovative functions and features. Oven configuration available as a mirrored system.



Steam **BOX** EVOLUTION

The Steambox Evolution range starts a new era, where technological research defines commercial cooking.

Accessories



Smoker -
External Digital Smoker
10 Amp plug & lead
supplied

USB -
External memory with
stored recipes.

Hood -
For when onsite
canopy of extraction
is not available



woodson
Countertop Equipment

Culinaire
Reliable Kitchen
Equipment Products

ASADO
Live Fuel cooking

Halton
Kitchen exhaust systems

airex
Refrigeration & Display

STODDART
PLUMBING PRODUCTS

KOLDTECH
Heated & refrigerated
food displays

GIORIK
Essence of evolution

CookTek
Unique induction cooking

Electrolux
PROFESSIONAL
The world's most innovative
kitchen technology

ANETS
American built fryers

STODDART
INFRASTRUCTURE

METRO
Shelving and
materials handling

AMERICAN RANGE
Heavy duty cooking range

ADANDE
Refrigerated
Drawers

**SIMPLY
STAINLESS**
Modular stainless steel
benching and shelving

power soak
Pot washer, continuous
motion system

TOWN&PARK
Sophisticated outdoor
furniture solutions

Perf
Perforated metal designs

STODDART

Brisbane

Sydney

Melbourne

Perth

Adelaide

1300 79 1954
www.stoddart.com.au

Auckland

0800 79 1954
www.stoddart.co.nz

Manufactured or Imported
& distributed exclusively by:

