

RG-50



Vegetable Preparation Machine

Food Preparation Machines - Made in Sweden 

2 kg /min

80 /day



halde.com

Ergonomics in all stages

The RG-50 is the most compact vegetable preparation machine from HALLDE. It is developed to suite smaller kitchens and the compact design makes RG-50 easy to put away and bring back when needed. The machine is a table top and can be used directly on the kitchen workbench. RG-50 pusher plate is swung up in a bow shape angle. This together with the low height makes for a better working posture.

Safe and quick top ups

Thanks to the automatic start and stop function the machine stops as soon as the pusher plate is swung up. When it is swung back the machine restarts and you can continue working. A clear advantage, particularly when larger volumes are involved.

Double safety against unprotected blades

If the feed cylinder is removed the power is cut. Thanks to this double security there is no risk of the machine starting with an unprotected blade.

Developed for the best hygiene

The RG-50 is manufactured solely from hygiene certified material. The machine has smooth surfaces, rounded edges and has no unnecessary recesses where food might penetrate and get stuck.

Easy cleaning

For quick cleaning, all loose parts are simple to remove for easy rinsing of the machine. The feed cylinder is removable and can be washed in a dishwasher.

Only the best material

The machine base is made of robust ABS-plastic, the feed cylinder and pusher plate are made of strong polycarbonate. Only top quality stainless steel is used to manufacture the cutting tool knife blades.

Lightweight and easy to move

The small size of the machine gives several advantages. It does not take up a lot of space in the kitchen. And it is easy to move, something which is helped by the generously sized handles on the sides.

Highest possible reliability

The powerful motor has a high starting and running torque and powers the cutting tool via a self-tensioning belt. The motor speed is geared down which makes the RG-50 an exceptionally reliable machine – irrespective of the products you are preparing.

Cutting tools with complete register

Our wide range of cutting tools means the RG-50 can handle every conceivable task. You choose the cutting tool you need to improve efficiency throughout the kitchen. The RG-50 slices, dices, grates/shreds, cuts juliennes and crimping slices – everything from firm to soft products.

Always perfect cutting results

The rotation speed of the cutting tools is optimised for cutting fine and even slices as efficiently as possible. The blades are purposely sharpened to avoid inertia or the edge breaking off.

Accessories that simplify life in your kitchen

• Recommended Cutting tool pack

2-pack Cutting Tools:
Slicer 4 mm
Grater/Shredder 4 mm
4-pack Cutting Tools:
Slicer 2 mm
Slicer 4 mm
Grater/Shredder 4 mm
Julienne Cutter 2x2 mm



• Cleaning brushes in two sizes

Used for cleaning machines and cutting tools. Both have coarse bristles that are particularly effective for cleaning Dicing Grids and Julienne Cutters.



• Wall rack for Cutting Tools

Provides space for three cutting tools and a quick overview of the entire range, saving space and making handling safe and comfortable – an effective way of protecting the edges of the blades from unnecessary wear.

















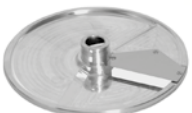













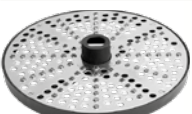



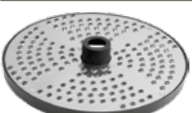





Result- och inspiration videos →

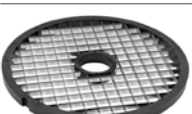

High quality cutting tools for best results

All cutting tools are dishwasher safe.  Replaceable knives / plates.  = Stainless steel.

	Slicers  1, 2, 4, 6 mm  0.5, 1.5, 3, 5, 7, 8, 9, 10 mm	Slices firm and soft vegetables, fruits, mushrooms etc. Dices when combined with a suitable Dicing Grid. Cuts potato chips in combination with Potato Chip Grid.	
	Fine Cut Slicer  15 mm	Slices firm and soft vegetables, fruits, mushrooms etc. Dices when combined with a suitable Dicing Grid.	
	Soft Slicers  8, 10, 12, 15 mm	Slices soft vegetables, fruits, mushrooms etc. Preferably used when dicing soft products, in combination with a suitable Dicing Grid.	
	Crimping Slicers  4 mm  2, 3, 5, 6 mm	Cuts decorative rippled slices of beetroot, cucumber, carrots, etc.	
	Julienne Cutters  2x2, 4x4 mm  2x6, 3x3 mm	Cuts julienne of firm products for soups, salads, stews, decorations etc. Suitable to cut slightly curved potatoes chips.	
	Grater/Shredders  2, 4, 6 mm.  1.5, 3, 4.5, 8, 10 mm	Grates carrots and cabbage for raw salads. Grates nuts, almonds and dry bread. Grater 6 or 8 mm is commonly used for grating cheese for pizza and when shredding cabbage.	
	Fine Grater  	For finely grating products such as raw potatoes for Swedish potato pancakes and bread for making breadcrumbs.	
	Hard Cheese Grater  	Ideal for grating hard cheese such as parmesan. Produces a somewhat coarser grate than the Fine Grater, Extra fine.	
	Fine Grater, Extra fine  	Grates products very finely, such as black radish grated for purée and potatoes for mashing.	
	Dicing Grid  8x8, 10x10, 12x12, 15x15, 20x20 mm	Cuts dices in combination with a suitable type of Slicer. Dice both hard and soft vegetables, fruits etc.	
	French Fries kit  10x10 mm	Kit containing French Fries Slicer and French Fries tool used together to cut French fries.	

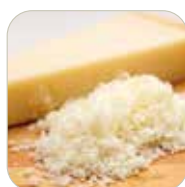



Machine

- Motor: 1.0 kW. One-speed. 120 V, single phase, 60 Hz. 220-240 V, single phase, 50-60 Hz.
- Transmission: Toothed belt.
- Safety system: Two safety switches.
- Degree of protection machine: IP34.
- Power supply socket: Earthed, single phase, 10 A.
- Fuse: 10 A, delayed action fuse.
- Sound level LpA (EN31201): 76 dBA.
- Magnetic field: Less than 15 microtesla.

Materials

- Machine base: ABS-plastic
- Knife chamber: Aluminium.
- Feeder: Polycarbonate and polyamide.
- Ejector plate: Acetal.
- Cutting tool disks: Stainless steel/ Aluminium/ Fiberglass reinforced polyamide.
- Cutting tool knives: Stainless steel.

Feeder

- Feed cylinder: Volume 0.9 litre. Height 185 mm. Diameter 170 mm.
- Feed tube with internal diameter 53 mm.

Cutting tools

- Diameter: 185 mm.
- Speed: 500 rpm (50 Hz).

Type of preparation

- Slices, dices, grates, shreds, cuts julienne, French fries and crimping slicers.
- Processes vegetables, fruit, dry bread, cheese, nuts, mushrooms etc.

Users

- Restaurants, shop kitchens, cafés, bakeries, diet kitchens, retirement homes, schools, fast food outlets, day care centres, salad bars, etc.

Net weights

- Machine: 8.6 kg.
- Cutting plates: 0.3 kg. French Fries kit: 0.9 kg.

Standards

- Directive: Visit hallde.com and select product and Certification.

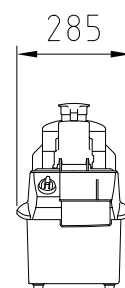
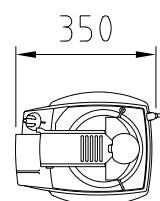
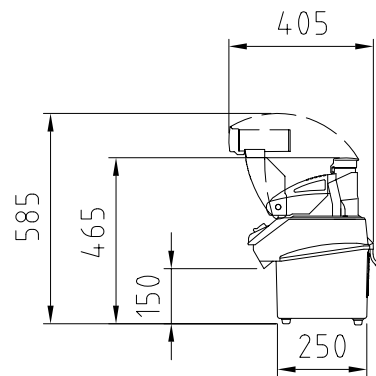

Food Preparation Machines
Made in Sweden since 1941

AB Hallde Maskiner – P.O. Box 1165 SE-164 26 Kista Sweden
• Phone: +46 8 587 730 00 • Fax: +46 8 587 730 30 • hallde.com • info@hallde.com

