

Ice Maker Series

Ice Makers

Self-contained underbench
Modular

SKOPE & ITV self-contained and modular Ice Makers offer superior energy-efficient solutions that respond to the needs of demanding food service, grocery and hospitality industries.



ALFA NDP20 A



ALFA NG30 A



ALFA NG45 A



ALFA NG60 A



ALFA NG80 A



SPIKA MS220 A HD



GALA MDP150 A

Stocked Models
Standard finish: Stainless Steel only

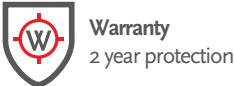

Quick Guide

Self-contained Features

Storage bin incorporated

Patented unique flexible spray rubber nozzles

Dynamic production, ice forms in thin layers avoiding trapped gases

Tough & reliable

Strong stainless steel frame

Fits under standard height commercial kitchen benches

Silent rain system

Patented robust folding door

Benefits

Space savings

Reduce the build-up of lime-scale

Crystal clear ice cubes. Only the purest of ice cubes are produced.

Lasts longer. Easy to programme, disassemble and service

Box-type frame with AISI 304 stainless steel pillars, easy to service without disassembling the whole machine

Easy access to ice, without taking up additional floor space

Quieter working environment

Hard-wearing & dampening system for long-life

Modular Features

Storage bin required - variety of sizes available

Tough & reliable

New water distributor system

Typically a harder, long-lasting ice cube

Vertical evaporator system

Benefits

Maximise storage capacity

Designed to stand up to the quick pace of fast-food establishments.

Increases resistance against lime-scale build up

Ideal for cooling beverages quickly. Enjoy a cool drink in seconds

Purest water, forming transparent crystalline ice without hollows or ridges.

ALFA NDP₂₀ A - SELF-CONTAINED

ICE PRODUCTION PER 24 HRS

= Air Temperature = Water Temperature

	ICE PRODUCTION PER 24 HRS	STORAGE	ICE CUBES PER CYCLE	kWh PER 100 kg	WATTS	DIMENSIONS - MM	NET WEIGHT
ALFA NDP ₂₀ A	24 kg	6kg / 400 cubes	18	27	325	350 W x 475 D x 595 H	32kg

OPERATING CONDITIONS

°C	10°	15°	21°	30°
10°	27	26	23	20
21°	25	24	22	19
32°	22	20	17	15
43°	19	16	12	9

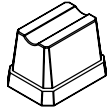

MINI ALFA 14-17cc
35 W x 25 D x 22 H / mm
(Average Dimensions)

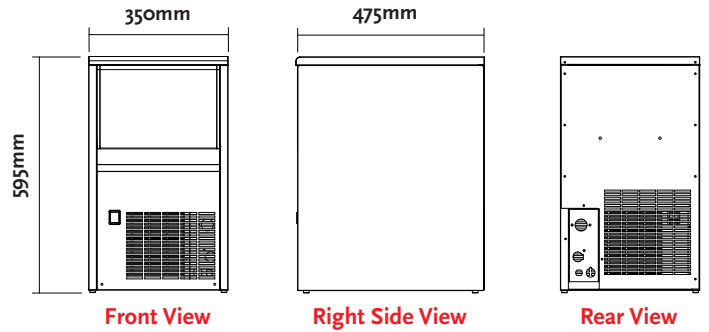

ALFA NG₃₀ A - SELF-CONTAINED

ICE PRODUCTION PER 24 HRS

= Air Temperature = Water Temperature

	ICE PRODUCTION PER 24 HRS	STORAGE	ICE CUBES PER CYCLE	kWh PER 100 kg	WATTS	DIMENSIONS - MM	NET WEIGHT
ALFA NG ₃₀ A	30 kg	15kg / 882 cubes	24	24.6	402	405 W x 515 D x 750 H	40kg

OPERATING CONDITIONS

°C	10°	15°	21°	30°
10°	32	32	28	23
21°	30	30	26	21
32°	27	27	23	18
43°	21	20	16	11

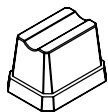

MINI ALFA 17-21cc
39 W x 27 D x 30 H / mm
(Average Dimensions)

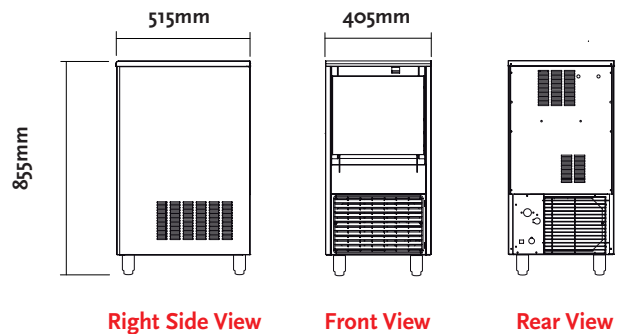

ALFA NG45 A - SELF-CONTAINED

ICE PRODUCTION PER 24 HRS

= Air Temperature = Water Temperature

	ICE PRODUCTION PER 24 HRS	STORAGE	ICE CUBES PER CYCLE	kWh PER 100 kg	WATTS	DIMENSIONS - MM	NET WEIGHT
ALFA NDP20 A	45 kg	20kg / 1176 cubes	30	24	580	465 W x 595 D x 795 H	50kg

OPERATING CONDITIONS

	10°	15°	21°	30°
10°	48	47	45	42
21°	46	45	43	40
32°	39	37	33	31
43°	30	28	23	19

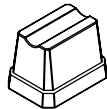

ALFA 17-21cc
39 W x 27 D x 30 H / mm
(Average Dimensions)

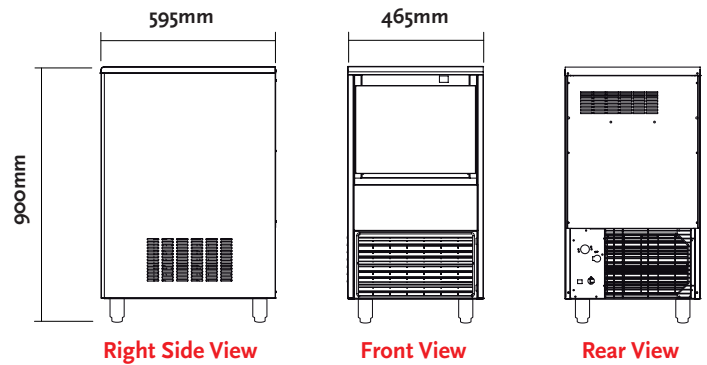

ALFA NG60 A - SELF-CONTAINED

ICE PRODUCTION PER 24 HRS

= Air Temperature = Water Temperature

	ICE PRODUCTION PER 24 HRS	STORAGE	ICE CUBES PER CYCLE	kWh PER 100 kg	WATTS	DIMENSIONS - MM	NET WEIGHT
ALFA NG60 A	60 kg	25kg / 1471 cubes	45	19.7	590	535 W x 595 D x 795 H	56kg

OPERATING CONDITIONS

	10°	15°	21°	30°
10°	67	63	58	23
21°	65	60	55	47
32°	55	50	46	38
43°	44	38	35	26

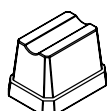

ALFA 17-21cc
39 W x 27 D x 30 H / mm
(Average Dimensions)

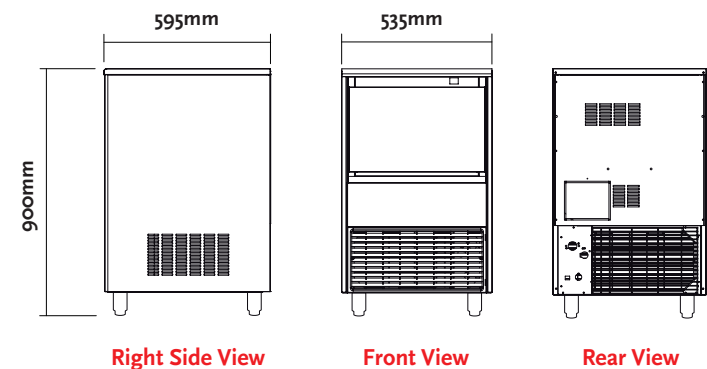

ALFA NG80 A - SELF-CONTAINED

ICE PRODUCTION PER 24 HRS

= Air Temperature = Water Temperature

	ICE PRODUCTION PER 24 HRS	STORAGE	ICE CUBES PER CYCLE	KWH PER 100 KG	WATTS	DIMENSIONS - MM	NET WEIGHT
ALFA NG80 A	80 KG	35kg / 2059 cubes	60	24.9	800	715 W x 595 D x 945 H	69kg

OPERATING CONDITIONS

	10°	15°	21°	30°
10°	87	86	75	63
21°	81	80	69	56
32°	73	72	62	49
43°	55	54	44	31

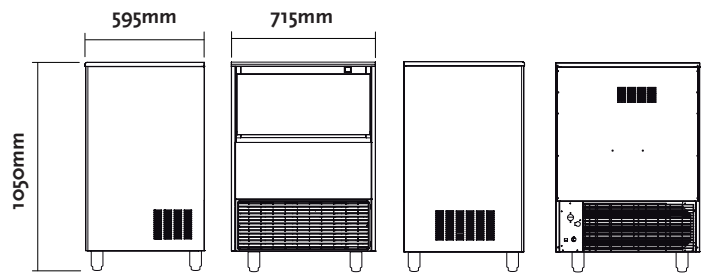

Right Side Front View Left Side Rear View

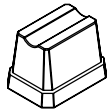

ALFA 17-21cc
39 W x 27 D x 30 H / mm
(Average Dimensions)

SPIKA MS220 A HD - MODULAR

ICE PRODUCTION PER 24 HRS

= Air Temperature = Water Temperature

	ICE PRODUCTION PER 24 HRS	STORAGE	ICE CUBES PER CYCLE	kWh PER 100 kg	WATTS	DIMENSIONS - MM	NET WEIGHT
SPIKA MS220 A HD	220 kg	Bins to suit	1" - 200 / 13cc 1/2" - 400 / 6.5cc	9.9	1220	762 W x 620 D x 500 H	85kg

OPERATING CONDITIONS

	10°	15°	21°	30°
10°	241	230	216	210
21°	230	220	203	199
32°	184	165	153	149
43°	160	133	125	121

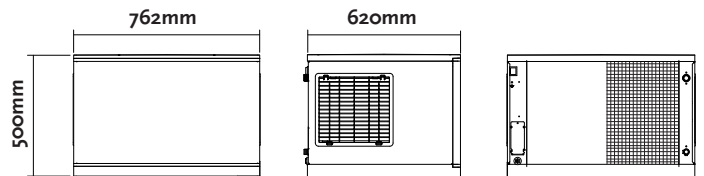

Front View Right Side View Rear View

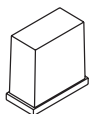

SPIKA HD 6.5cc
26 W x 11 D x 23 H / mm
(Average Dimensions)

MDP150 A - MODULAR

ICE PRODUCTION PER 24 HRS

= Air Temperature = Water Temperature

	 ICE PRODUCTION PER 24 HRS	STORAGE	ICE CUBES PER CYCLE	kWh PER 100 kg	WATTS	DIMENSIONS - MM	NET WEIGHT
MDP150	150 kg	Bins to suit	84	20	1200	775 W x 805 D x 625 H	70kg

OPERATING CONDITIONS

	10°	15°	21°	30°
10°	163	161	142	118
21°	151	150	130	106
32°	138	136	116	92
43°	104	102	83	59

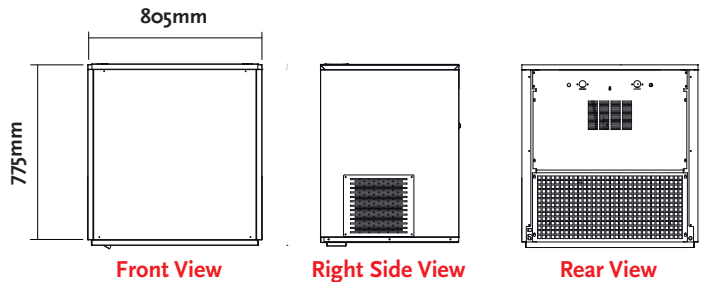

GALA 23-30CC
40 W x 34 H / mm
(Average Dimensions)

Silo S220

230 KG

- The S220 Silo storage bin is an indispensable item when producing large amounts of ice. ITV Bins can help you store or transport ice hygienically. Suitable for GALAMP150 A and SPIKA MS220 A HD models.
- ITV have a wide range of storage bins to adapt to any ITV ice maker and to respond to all requirements. The bins help you remove the ice, avoiding spills. Additionally, the transfer of ice is three times faster, which saves time and work.













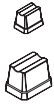

762 W x 819 D x 1071 H

Silo S220

Accessories

Type	Picture	Models
Stacking Kit		ITV 6586 - for Spika MS220 and MS410 ITV 8034 - for Gala MDP150 ITV 8035 - for Gala MR400
Water Filter		SXX11695 for Self-Contained SSX11698 for Modular SSX11696 Replacement Cartridge
Pump		PRO SA92 SaniCondens

Ice Makers - Full Range

Type of Ice	Ice Shape	Product Series	Key Benefits	Key Use	Ice Maker Type
Cubes	Pyramid 	 Mini Alfa & Alfa	<ul style="list-style-type: none"> ✔ Pure, transparent crystalline ice ✔ Consistent ice from water spray system ✔ Slow melting ice ✔ Large ice surface area to cool drinks fast ✔ High volume production 	<ul style="list-style-type: none"> - Drinks & Cocktails - Compact Ice makers save room - Designed to fit under benchtops. - Food service & bar establishments 	Self-Contained (Ice storage incorporated)
	Cone 	 Gala	<ul style="list-style-type: none"> ✔ Premium Ice - pure & translucent ✔ Truncated cone shape - elegant look ✔ Doesn't alter a drinks flavour ✔ Cools a drink with minimal dilution 	<ul style="list-style-type: none"> - Cocktail Drinks - Scotch & Whiskey 	Modular (Separate storage bin required)
	Dice 	 Spika  Spika	<ul style="list-style-type: none"> ✔ Hard long lasting ice ✔ Cools drinks instantly ✔ Large ice consumption ✔ High ice to water ratio - more cooling power 	<ul style="list-style-type: none"> - Fast food establishments - Quick service restaurants - Ideal for soft drinks - Half cube ideal for blended beverages 	Self-Contained (Ice storage incorporated) Modular (Separate storage bin required)
Granular	Granular - dry 	 Ice Queen	<ul style="list-style-type: none"> ✔ Resembles crushed or chipped ice ✔ Softer than cubes ✔ Quickest cooling of all the ice types ✔ Dry - fast cooling & long life ✔ Wet - preserves the food moisture 	<ul style="list-style-type: none"> - Processing & Transportation - Safe option for perishable foods - Cocktails (dry) - Food Storage eg. fish, meat, dairy (wet) 	Self-Contained (Ice storage incorporated)
	Granular - wet 	 Ice Queen			Modular (Separate storage bin required)
All		 Silo	<ul style="list-style-type: none"> ✔ Single formed food grade plastic lining with wide covered corners to hygenically store ice. ✔ Remove Ice quickly with no spillage ✔ Use in conjunction with Ice Makers listed above 	<ul style="list-style-type: none"> - For large ice production - Refer Silo Bin compatibility table - Save time and work when transferring Ice by using ITV bins with carts (enquire about models available) 	Storage Bin
		 Silo with cart			Storage Bin with Cart

Product Models	Ice Sizes (cc)	kg* Production /24hrs	Storage (kg)	External Dimensions (W x D x H)	Ex-Stock ** or Order	Silo Bin Compatibility		
						1 Ice Maker ■	2 Ice Maker ■■	2 Ice Maker ■■■
▲ ALFA NDP20 A	14	24	6	350 x 475 x 595	Ex-Stock	—	—	—
▲ ALFA NG30 A	20	30	15	405 x 515 x 750	Ex- Stock	—	—	—
▲ ALFA NG35 A	20	35	20	465 x 595 x 795	Order	—	—	—
▲ ALFA NG45 A	20	45	20	465 x 595 x 795	Ex- Stock	—	—	—
▲ ALFA NG60 A	20	60	25	535 x 595 x 795	Ex- Stock	—	—	—
▲ ALFA NG80 A	20	80	35	715 x 595 x 945	Ex- Stock	—	—	—
▲ ALFA NG110 A	20	110	60	715 x 700 x 1050	Order	—	—	—
▲ ALFA NG150 A	20	150	75	860 x 700 x 1050	Order	—	—	—
GALA MDP150 A	25	150	—	775 x 805 x 625	Ex- Stock	S220	S220, S350, S400	—
■ GALA MR400 A	25	400	—	1321 x 978 x 638	Order	S500, S700	S500, S700	—
SPIKA NG60 A HD	6.5	60	20	535 x 595 x 795	Order	—	—	—
SPIKA NG90 A HD	6.5	90	32	660 x 700 x 838	Order	—	—	—
SPIKA NG110 A HD	6.5	110	35	660 x 700 x 838	Order	—	—	—
SPIKA NG140 A HD	6.5	140	45	762 x 762 x 838	Order	—	—	—
SPIKA MS300 SLIM A HD	6.5	300	—	559 x 621 x 659	Order	S160, S220, S350, S400	—	—
■ SPIKA MS220 A HD	6.5	220	—	762 x 620 x 500	Ex- Stock	S220, S350, S400	220, S350, S400, S500, S700	—
■ SPIKA MS410 A HD	6.5	405	—	762 x 620 x 760	Order	S220, S350, S400, S500, S700	S220, S350, S400, S500, S700	—
IQ 50 A	—	58	20	465 x 595 x 790	Order	—	—	—
IQ 85 A	—	85	20	465 x 595 x 790	Order	—	—	—
IQ 135 A	—	135	60	515 x 550 x 1355	Order	—	—	—
IQ 150 A	—	140	—	515 x 550 x 486	Order	S80, S160, S220	—	S350, S400
IQ 200 A	—	220	—	515 x 550 x 575	Order	S80, S160, S220, S350	—	S350, S400
IQ 400 A	—	390	—	675 x 550 x 660	Order	S220, S350, S400, S500	—	S500, S700
IQ 550 A	—	565	—	675 x 550 x 800	Order	S220, S350, S400, S500	—	S500, S700
IQ 1100 A	—	1125	—	1335 x 610 x 815	Order	S500, S700	—	—
S80	—	—	80	685 x 555 x 870	Order	—	—	—
S160	—	—	181	559 x 872 x 870	Order	—	—	—
S220	—	—	230	762 x 819 x 1071	Ex- Stock	—	—	—
S350	—	—	340	1067 x 819 x 1071	Order	—	—	—
S400	—	—	390	1219 x 819 x 1071	Order	—	—	—
S500	—	—	480	1321 x 872 x 1122	Order	—	—	—
S700	—	—	676	1524 x 788 x 1537	Order	—	—	—
SCS150	—	—	140	762 x 1163 x 1320	Order	—	—	—
SCS300	—	—	300	762 x 1163 x 1865	Order	—	—	—
SCD400	—	—	413	1524 x 1163 x 1520	Order	—	—	—
SCD600	—	—	617	1524 x 1163 x 1820	Order	—	—	—
SCD800	—	—	812	1524 x 1163 x 2084	Order	—	—	—
EASY CART	—	—	112	622 x 1054 x 887	Order	—	—	—
6 TOTE KIT	—	—	70	—	Order	—	—	—

* Based on 21°C air temperature + 15°C water temperature

** Refer SKOPE Price Book for further information

▲ Models also available in Gala, Delta, Super Star & Super Star Plus Ice (indent basis)

■ Models also available with remote refrigeration (indent basis)